



All stainless steel contact pressure gauges for the chemical industry

with or without dampening liquid filling

Nominal size DS 160

Accuracy class 1,0
According to DIN EN 837-1

Features

Modular construction system ensures high reliability and long service life
Measuring system stainless steel 1.4571
Protection to IP 65
Liquid dampening provides vibration-free display

Applications

Process engineering
Mechanical engineering and plant construction
Water treatment
Food industry



Design	with silicon oil filling			
Case diameter	DS 160	DS 160	DS 160 filled	DS 160 filled
Connection	bottom	back, eccentric	bottom	back, eccentric
Ranges in bar	0...1, 1,6, 2,5, 4, 6, 10, 16, 25, 40, 60, 100, 160, 250, 400, 600, 1.000, 1.600 -1 / 0, -1 / +0,6, -1 / +1,5, -1 / +3, -1 / +5, -1 / +9, -1 / +15			
Applications	Constant load : up to full scale value Alternating load: up to 0,9 x full scale value Short-time: overload capacity 1,3 x full scale value			
Case	CrNi steel			
Bayonet ring	CrNi steel			
Window	Polycarbonate			
Dial	Aluminium white, scale and imprint black to DIN 16109			
Pointer	Aluminium, black			
Movement	CrNi steel			
Measuring element	CrNi steel, to 40 bar with bourdon tube, from 60 bar helical tube			
Pressure Connection	SW 22, CrNi steel			
Connection thread	G 1/2 B			
Protection	IP 54 to EN 60529 / IEC 529		IP 65 to EN 60529 / IEC 529	
Temperatures	Medium: -20°C to 80°C, Ambient: -25°C to 60°C			
Weight	1,8 kg		3,3 kg	

Dimensions

Connection bottom

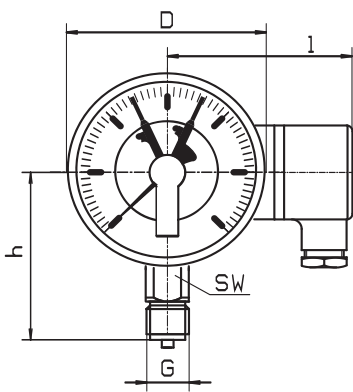

Connection back, eccentric

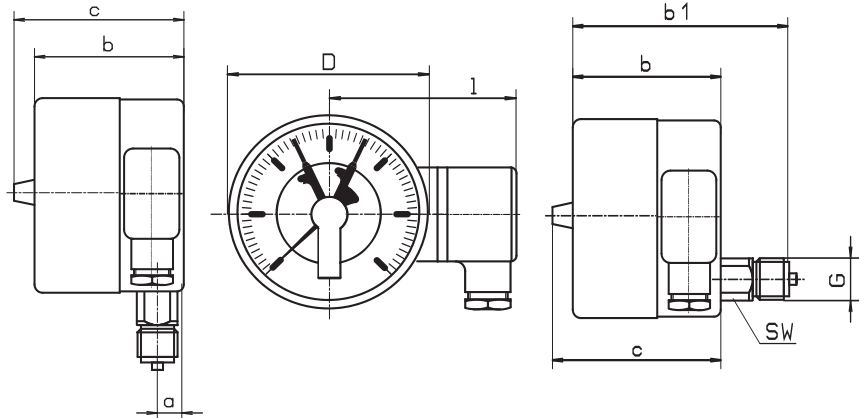

Front / rear mounting flange

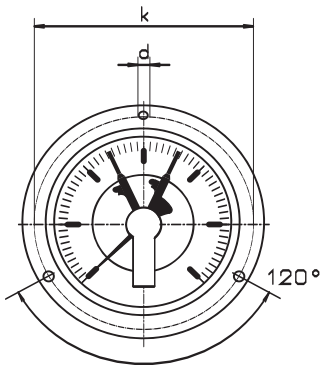

rear mounting flange

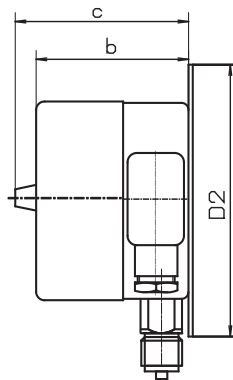

front mounting flange

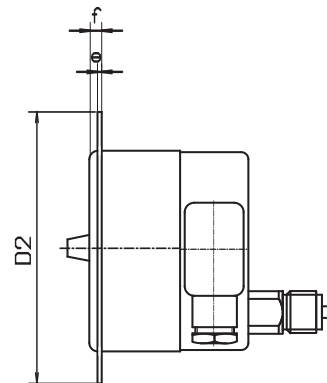

Dimensions in mm

DS	D	a	b	b1	h		D2	e	f	k	d	sw	G
160	160	15	97	-	118		196	3	8	178	5,6	22	1/2" BSP male
160	160	-	97	132	-		196	3	8	178	5,6	22	1/2" BSP male

DS	c	l
160	107	118
160	107	118



Grenzsignalgeber mit Magnetspring-Kontakt *Alarm contacts with magnetic snap-action contact*

Anwendung:

Elektromechanische Grenzsignalgeber sind Hilfsstromschalter, die elektrische Stromkreise schließen und öffnen. Der Magnetspringkontakt ist ein mechanischer Berührungskontakt zur Schaltung von Leistungen bis 30 W / 50 VA. Die Signalgabe erfolgt nacheilend oder voreilend analog der Bewegung des Istwertzeigers. Messgeräte mit Magnetspringkontakt sind allgemein einsetzbar. Die Verwendung von Dämpfungsfüssigkeit im Messgerät ist möglich und verbessert das Verschleißverhalten.











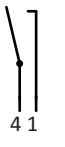

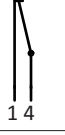



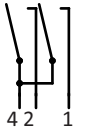

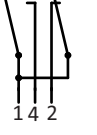
Service intended:

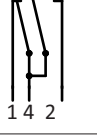
Electromechanical alarm contacts are auxiliary contacts that make or break electric circuits. A magnetic snap-action contact is a mechanical contact with a make/break capacity up to 30 W / 50 VA. The signal output will be retarded or advanced and analog to the movement of the instrument pointer. Instruments with magnetic snap-action contacts can be used for all operating conditions, also with liquid-filled instrument (which improves the wear resistance).

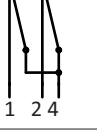
Technische Daten	Technical Data
Kontaktarmlager	Contact arm bearing
Rubin-Lagersteine	Ruby stones
Kontaktmaterial	Material of contact points
Ag80 Ni20 (optional 10µm vergoldet)	AG 80 Ni 20 (optional 10µm gold plated)
Anzahl der Kontakte	No. of contacts
maximal 4	Max. 4
Nennbetriebsspannung	Voltage
$U_{eff} \text{ min} : 24 \text{ V}$	Min. $U_{eff} : 24 \text{ V}$
$U_{eff} \text{ max} : 250 \text{ V}$	Max. $U_{eff} : 250 \text{ V}$
Nennbetriebsstrom	Current rating
Einschaltstrom : 1,0 A	Make rating : 1,0 A
Ausschaltstrom : 1,0 A	Break rating : 1,0 A
Dauerstrom : 0,6 A	Continuous load : 0,6 A
Schaltleistung	Load
$P \text{ min} : 0,4 \text{ W} / 0,4 \text{ VA}$	$P \text{ min.} : 0,4 \text{ W} / 0,4 \text{ VA}$
$P \text{ max} : 30 \text{ W} / 50 \text{ VA}$	$P \text{ max.} : 30 \text{ W} / 50 \text{ VA}$
Schaltgenauigkeit	Accuracy
ca. 2%-5% FS	Approximately 2 - 5,0 % FS
Kriech- und Luftstrecken	Creep and air distances
nach DIN VDE 0110 Teil 1 und 2 (Verschmutzungsgrad 3)	To DIN VDE 0110 part 1 and 2 (degree of soiling: 3)

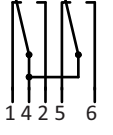
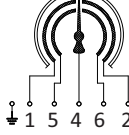
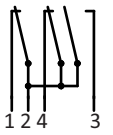
Grenzsignalgeber mit Magnetspring-Kontakt
Alarm contacts with magnetic snap-action contact

Kontakt schließt <i>Contact closes</i>					M 1
Kontakt öffnet <i>Contact breaks</i>					M 2
Kontakt wechselt <i>Contact changes</i>					M 3
1. Kontakt schließt <i>1st Contact closes</i>	2. Kontakt schließt <i>2nd Contact closes</i>				M 11
1. Kontakt schließt <i>1st Contact closes</i>	2. Kontakt öffnet <i>2nd Contact breaks</i>				M 12
1. Kontakt öffnet <i>1st Contact breaks</i>	2. Kontakt schließt <i>2nd Contact closes</i>				M 21
1. Kontakt öffnet <i>1st Contact breaks</i>	2. Kontakt öffnet <i>2nd Contact breaks</i>				M 22
1. Kontakt wechselt <i>1nd Contact changes</i>	2. Kontakt wechselt <i>2nd Contact changes</i>				M 33
1. Kontakt öffnet <i>1st Contact breaks</i>	2. Kontakt öffnet <i>2nd Contact breaks</i>	3. Kontakt schließt <i>3rd Contact closes</i>			M 221 ²⁾

¹⁾ Bei Vakuummetern bzw. Manometern mit kombiniertem Messbereich (Vakuum / Druck oder - / + °C) ist zu beachten, dass die Vakuumanzeige entgegen dem Uhrzeigersinn arbeitet.

¹⁾ With vacuum gauges or gauges with dual measuring range (vacuum / pressure or - / + °C) the vacuum indication approaches the set point in counterclockwise direction.

²⁾ Bei Dreifach- und Vierfachkontakten werden die Reihenfolge und die Schaltfunktionen im Uhrzeigersinn beschrieben.

²⁾ For triple and quadruple contacts the sequences and contact functions are described in clockwise direction.

Kontakt **M 3** = 1-fach Wechsler / Kontakt **M 33** = 2-fach Wechsler
 Contact **M 3** = change-over / contact **M 33** = double change over



Grenzsignalgeber mit Induktiv-Kontakt
Inductive alarm sensor contact

Anwendung:

Induktive Grenzsignalgeber sind elektrische Näherungsschalter nach DIN 19234 bzw. NAMUR und dürfen in explosionsgefährdeten Räumen der Gefahrenbereiche Zone 1 und 2 betrieben werden. Die Signalgabe erfolgt verzögerungsfrei analog der Bewegung des Istwertzeigers. Die Verwendung von Dämpfungsflüssigkeit im Messgerät ist möglich.

Bei Bestellung muss ausdrücklich darauf hingewiesen werden, wenn Einsatz in explosionsgefährdeter Umgebung vorgesehen ist.

Es muss ein geeigneter Schaltverstärker verwendet werden.







Service intended:

Inductive alarm sensor contacts are inductive contacts to DIN 19234 resp. NAMUR. They are certified for use in hazardous areas zone 1 and zone 2. The signal output is instantaneous and analog to the movement of the instrument pointer. Liquid filling in the instrument is possible. It has to be stated clearly in the order, if usage in intrinsically safe area is planned. A suitable switching amplifier has to be used.

Technische Daten	Technical Data
Kontaktarmlager	Contact arm bearing
Rubin-Lagersteine	Synthetic rubies
Anzahl der Kontakte	No. of contacts
maximal 4	Max. 4
Versorgungsstromkreis	Supply circuit
5 ... 6 V DC	5 ... 6 V DC
Nennspannung	Nominal voltage
8 V DC (Ri ≈ 1k)	8 V DC (Ri = 1 k)
Stromaufnahme	Current consumption
aktive Fläche frei : ≥ 3 mA	Active surface free : ≥ 3 mA
aktive Fläche bedämpft : ≤ 1 mA	Active surface damped : ≤ 1 mA
Schaltgenauigkeit	Accuracy
< 0,5% FS	< 0,5 % FS
Umgebungstemperatur	Ambient temperature
- 25 ... +100°C	- 25 ... +100°C
Konformitätsbescheinigung	Certificate of conformity
PTB 99 ATEX 2219 ZELM 03 ATEX 0128 X KEMA 02ATEX1090 X	PTB 99 ATEX 2219 ZELM 03 ATEX 0128 X KEMA 02ATEX1090 X

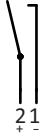
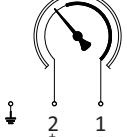
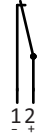
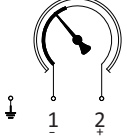
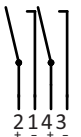
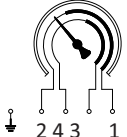
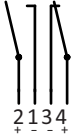

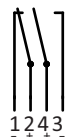
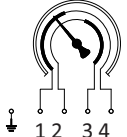
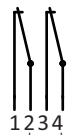
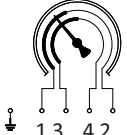
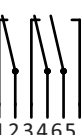
Grenzsignaleger mit Induktiv-Kontakt
Inductive alarm sensor contact

Kontakt schließt <i>Contact closes</i>					I 1
Kontakt öffnet <i>Contact breaks</i>					I 2
1. Kontakt schließt <i>1st Contact closes</i>	2. Kontakt schließt <i>2nd Contact closes</i>				I 11
1. Kontakt schließt <i>1st Contact closes</i>	2. Kontakt öffnet <i>2nd Contact breaks</i>				I 12
1. Kontakt öffnet <i>1st Contact breaks</i>	2. Kontakt schließt <i>2nd Contact closes</i>				I 21
1. Kontakt öffnet <i>1st Contact breaks</i>	2. Kontakt öffnet <i>2nd Contact breaks</i>				I 22
1. Kontakt öffnet <i>1st Contact breaks</i>	2. Kontakt öffnet <i>2nd Contact breaks</i>	3. Kontakt schließt <i>3rd Contact closes</i>			I 221 ²⁾

¹⁾ Der Ausgangsstrom fließt, wenn sich die Steuerfahne innerhalb des Steuerkopfes befindet. Bei Vakuummetern bzw. Manometern mit kombiniertem Messbereich (Vakuum / Druck oder - / + °C) ist zu beachten, dass die Vakuumanzeige entgegen dem Uhrzeigersinn arbeitet.

¹⁾ The Output current will flow when the metal flag is inside the sensor. With vacuum gauges or gauges with dual measuring range (vacuum / pressure or - / + °C) the vacuum indication approaches the set point in counterclockwise direction.

²⁾ Bei Dreifach- und Vierfachkontakten werden die Reihenfolge und die Schaltfunktionen im Uhrzeigersinn beschrieben.

²⁾ For triple and quadruple contacts the sequences and contact functions are described in clockwise direction.

Kabel Dosen-Anschlusspläne

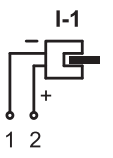
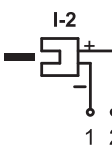
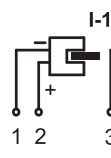
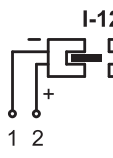
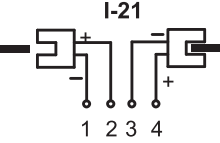
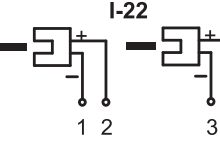

Grenzsignalgeber mit Elektronik-Kontakt
Alarm contacts with electronic contact

Anwendung:

Elektronische Grenzsignalgeber sind Hilfsstromschalter für Spannungen im Bereich 10...30 VDC, die zur direkten Ansteuerung einer SPS oder anderer elektronischer Geräte verwendet werden. Die Signalgabe erfolgt verzögerungsfrei analog der Bewegung des Istwertzeigers. Die Verwendung von Dämpfungsflüssigkeit im Messgerät ist möglich.







Service intended:

Electronic alarm sensor contacts are switches for tensions out a range of 10...30 VDC used for direct drive of a stored program system or other electronics. The signal output is instantaneous and analog to the movement of the instrument pointer. Liquid filling in the instrument is possible.

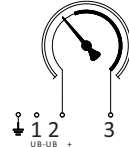

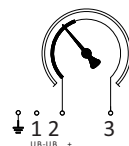
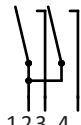
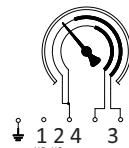
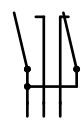
Technische Daten	Technical Data
Kontaktarmlager	Contact arm bearing
Rubin-Lagersteine	Ruby stones
Anzahl der Kontakte	No. of contacts
maximal 4	Max. 4
Betriebsspannung	Operating voltage
U _b = 10 ... 30 V DC, Restwelligkeit 10%	U _b = 10 ... 30 V DC, Residual ripple 10 %
Leerlaufstrom:	Open circuit current
≤ 10 mA	≤ 10 mA
Verpolungsschutz	Reverse battery protection
bedingt (U _b)	conditional on (U _b)
Induktionsschutz	inductive protection
1 kV, 0,1 ms, 1k	1 kV, 0,1 ms, 1k
Oszillatorfrequenz	Oscillator frequency
ca. 1000 kHz	approx. 1000 kHz
Ausgangsart	Output type
PNP - Schließer	PNP - make contact
Schaltstrom	Switching current
I _{max} ≤ 100 mA	I _{max} ≤ 100 mA
Reststrom	Residual current
≤ 100 mA	≤ 100 mA
Spannungsabfall (bei I _{max})	Voltage drop (at I _{max})
≤ 0,7 V	≤ 0,7 V
Schalthysterese	Switching hysteresis
0,08 ... 0,30 mm	0,08 ... 0,30 mm
Temperaturdrift	Temperature drift
± 0,02 mm	± 0,02 mm
Isolationsfestigkeit	Insulation resistance
0,5 kV	0,5 kV
Umgebungstemperatur T _{min} / T _{max}	Ambient temperature T _{min} / T _{max}
- 25 ... + 70°C	- 25 ... + 70°C

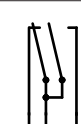
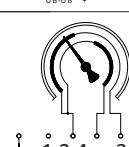
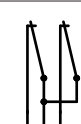
Grenzsignalleger mit Elektronik-Kontakt
Alarm contacts with electronic contact

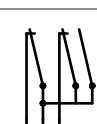
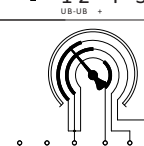
Kontakt schließt <i>Contact closes</i>					E 1
Kontakt öffnet <i>Contact breaks</i>					E 2
1. Kontakt schließt <i>1st Contact closes</i>	2. Kontakt schließt <i>2nd Contact closes</i>				E 11
1. Kontakt schließt <i>1st Contact closes</i>	2. Kontakt öffnet <i>2nd Contact breaks</i>				E 12
1. Kontakt öffnet <i>1st Contact breaks</i>	2. Kontakt schließt <i>2nd Contact closes</i>				E 21
1. Kontakt öffnet <i>1st Contact breaks</i>	2. Kontakt öffnet <i>2nd Contact breaks</i>				E 22
1. Kontakt öffnet <i>1st Contact breaks</i>	2. Kontakt öffnet <i>2nd Contact breaks</i>	3. Kontakt schließt <i>3rd Contact closes</i>			E 221 ²⁾

¹⁾ Der Ausgangsstrom fließt, wenn sich die Steuerfahne innerhalb des Steuerkopfes befindet. Bei Vakuummetern bzw. Manometern mit kombiniertem Messbereich (Vakuum / Druck) ist zu beachten, dass die Vakuumanzeige entgegen dem Uhrzeigersinn arbeitet.

¹⁾ The Output current will flow when the metal flag is inside the sensor. With vacuum gauges or gauges with dual measuring range (vacuum / pressure) the vacuum indication approaches the set point in counterclockwise direction.

²⁾ Bei Dreifach- und Vierfachkontakten werden die Reihenfolge und die Schaltfunktionen im Uhrzeigersinn beschrieben.

²⁾ For triple and quadruple contacts the sequences and contact functions are described in clockwise direction.

Kontakt **E 3** = 1-fach Wechsler / Kontakt **E 33** = 2-fach Wechsler
 Contact **E 3** = change-over / contact **E 33** = double change over