

INSTALLATION INSTRUCTIONS

DIAPHRAGM INSTRUMENTS

DIFFERENTIAL PRESSURE INSTRUMENT / SWITCH



For efficient working of your instrument, please read all instructions carefully before attempting to install.

CAUTION : Do not exceed maximum operating pressure given on the instrument label.

Check fluid compatibility with wetted parts before use.

For highly corrosive media, hazardous location or area please contact manufacturer.

OPERATING PRINCIPLE

High and Low pressures are separated by a sensor assembly consisting of a magnet, diaphragm and a range spring. The difference in pressure causes the sensor assembly to move in proportion to the change against a range spring.

A rotary magnet, located in a separate body compartment and isolated from the acting pressures, is rotated by magnetic coupling as per the linear movement of the sensor assembly. A pointer attached to the rotary magnet indicates differential pressure on the dial.

SWITCH : Reed switches are located adjacent to the pressure chamber and are activated by the magnetic field of the sensor assembly.

Note : The instruments are calibrated to give $\pm 2\%$ full scale accuracy on ascending readings.

INSTALLATION

For better performance the instrument should be mounted horizontally by keeping the dial vertical. Two mounting holes of size 1/4"UNC are provided at bottom of the instrument body for mounting (for model with inline porting). Select instrument location where it is not subjected to heavy vibrations or shocks.

NOTE : For models with back/bottom porting, mounting holes are provided on request.

Depressurize the system and connect the high and low pressure lines of your system to the "High" \oplus & "Low" \ominus ports of the instrument, respectively.

It is recommended to use "O" rings with male connectors to avoid excessive tightening and to prevent leakage (For parallel threads). The instrument is now ready for operation.

Apply "High" and "Low" pressures simultaneously, to avoid damage to the internal parts.

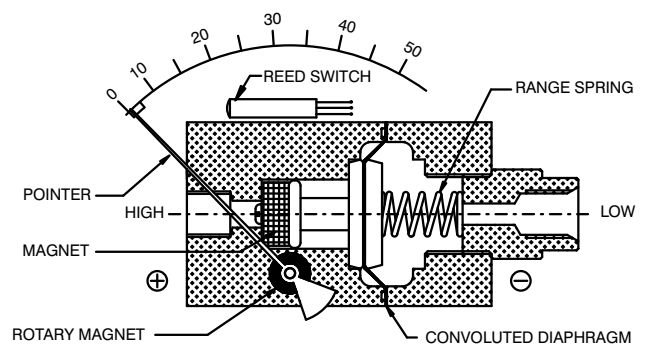

Instrument consists of a convoluted diaphragm to sense the pressure difference. It can withstand maximum operating pressure up to 100 bar for all ranges. If pressure exceeds the rated maximum pressure, "O" rings & diaphragm inside the pressure chamber, will be damaged. If maximum operating pressure is within the allowable limit of 100 bar, but the differential pressure exceeds instrument range, there will be no damage to the instrument. Pointer will only go the extreme right end of the scale.

PRECAUTIONS

Do not connect "High" and "Low" ports to wrong pipe ends. Do not subject the instrument to excessive vibration.

The instrument is never to be used in an area where a magnetic field is present. It may show wrong readings.

As the instrument works on magnetic coupling, use only non magnetic fittings, parts etc. in areas closer than 50 mm on all sides, otherwise calibration will get effected. Panel mounted instruments should be installed in non-ferrous panel material. However instruments with 2" and 2.5" dials, mounted in steel panels, may require pointer adjustment. This is done by the manufacturer.

Do not try to open any part of the instrument for any reason, because if not reassembled properly calibration will be affected.

SWITCH SETTING :

Please follow these instructions when your differential pressure instruments are supplied with switch. The switches are normally factory set to save time at customer's end. However they are field adjustable.

CAUTION : Supply should not exceed switch rating. For higher supply, use of relay circuit is recommended.

SWITCH ADJUSTMENT

Switch adjustment screw is located on plastic cover.

Rotate the screw anti-clockwise to increase the set point and clockwise to decrease the set point. One or two trials may be necessary to attain the exact set point. Above procedure to be followed by putting the instrument on test bed or while in actual service.

NOTE : Instrument and switch has IP65 protection. PG7 gland is provided for cables for terminal strip option (Use cable dia 3-6.5 mm). PG9 gland is provided for cables for DIN plug option (Use cable dia 4 - 8 mm).

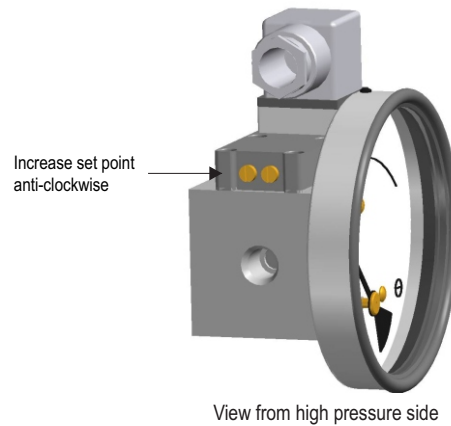

SPST SWITCH

Switches are provided as per customer requirement. Please refer gauge label for switch specification.

One SPST switch

Reed switches & terminal strip connection

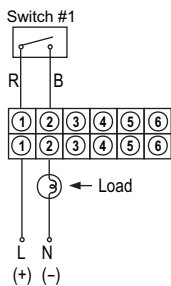

Two SPST switches

Reed switches & terminal strip connection

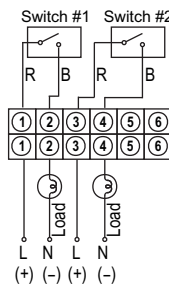

SPDT SWITCH

Switches are provided as per customer requirement. Please refer gauge label for switch specification.

One SPDT switch

Reed switches & terminal strip connection

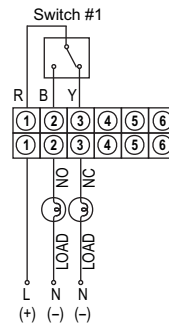

Two SPDT switches

Reed switches & terminal strip connection

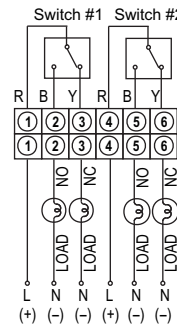

Reed switches & Din plug connection

View of socket for supply connections

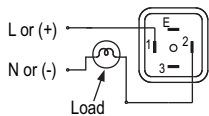

View of plug after removing the socket

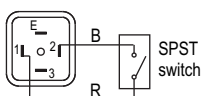

Reed switches & Din plug connection

View of socket for supply connections

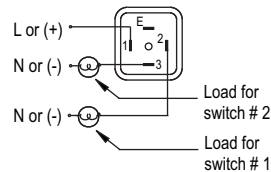

View of plug after removing the socket

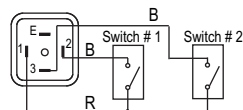

Reed switches & Din plug connection

View of socket for supply connections

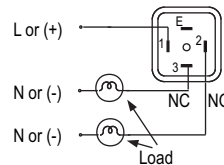

View of plug after removing the socket

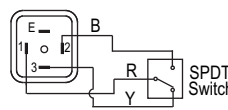

R=Red, B=Black, Y=Yellow, L=Live or +ve supply, N=Nutral or -ve supply

* Body to be suitably earthed while using gauge + switch and only switch.