

Electronic Pressure Calibrator LPC 300

Operating-Manual



Charge battery for about 8-12 hours before first use!
(see chapter 2, page 6)

Release notes:

Manual Rel. 050823 is for LPC 300 Firmware >= 21.04.03
Manual Rel. 050907 is for LPC 300 Firmware >= 28.07.04
Manual Rel. 051219 is for LPC 300 Firmware >= 30.08.04
Manual Rel. 070330 is for LPC 300 Firmware >= 36.11.05



DRUCK & TEMPERATUR Leitenberger GmbH
Bahnhofstr. 33 • D-72138 Kirchentellinsfurt • Germany • www.Leitenberger.com
Tel. +49-7121-90920-0 • Fax +49-7121-90920-99 • E-Mail: DT-Export@Leitenberger.de



Contents

Short overview	3
1. General Notes	4
1.1 General SAFETY notes	4
1.2 SAFETY notes about LPC 300 battery	5
2. Charging the LPC 300 battery	6
3. Connecting a system reference sensor LPC-S to the LPC 300	7
3.1 Mechanical connection of the reference sensor LPC-S	7
3.2 Electrical connection of the reference sensor LPC-S	7
3.2.1 Direct connection	7
3.2.2 Connection using the optional extension cable	8
4. Electrical Ports at the LPC 300	8
4.1 Electrical connection of a pressure switch	9
4.2 Electrical connection of a 2-wire pressure transmitter	10
4.3 Electrical connection of a 3-wire pressure transmitter	11
5. Calibration Setup	12
5.1 Examples	12
5.2 Standards for Calibration Setups	13
6. User interface	14
6.1 General usage notes	14
7. Menu structure (Operating Modes)	15
8. Screen displays	16
8.1 State screen (after switch-on of the LPC 300)	16
8.2 Screens of the three operating modes	17
8.2.1 Operating mode MEASURING	17
8.2.2 Operating mode CALIBRATION	18
8.2.3 Operating mode SWITCH-TEST	18
8.3 SETUP-Menu (settings)	19
9. Operating modes	20
9.1 Operating mode MEASURING - without unit under test (UUT)	20
9.2 Operating mode MEASURING - with unit under test (UUT)	21
9.3 Operating mode CALIBRATION	22
9.4 Operating mode SWITCH-TEST	24
10. SETUP-Menu	25
10.1 Menu "Functions"	25
10.2 Menu "LPC-Info"	26
10.3 Menu "Reference Sensor"	26
10.4 Menu "Ref. Sensor-list"	27
10.5 Menu "LPC-Configuration"	27
10.6 Menu "Interface"	28
11. ADDENDUM: Technical specification	29
11.1 Optional Accessories	30
12. Windows-Software LPC-Cal (optional)	31

**DRUCK & TEMPERATUR Leitenberger GmbH**Bahnhofstr. 33 • D-72138 Kirchentellinsfurt • Germany • www.Leitenberger.com
Tel. +49-7121-90920-0 • Fax +49-7121-90920-99 • E-Mail: DT-Export@Leitenberger.de

Short overview







Please read the **COMPLETE** manual intently, before you use the LPC 300 for the first time!



























The LPC 300 is equipped with a keypad with numeric keys, cursor keys and function keys.

Basic principle:

- Enter numeric values with numeric keys  and confirm with .
- Select items with cursor keys  and confirm with .

Example: you would like to check the accuracy of an analogue pressure gauge:

- ① Press  to enter the SETUP menu of the LPC 300.
- ② Highlight the entry "MEASURING" with the cursor keys  and confirm with .
- ③ The settings screen of the operating mode MEASURING is displayed.
- ④ Move the cursor with the cursor keys  to each item and describe the Unit Under Test (UUT):
 - Pressure range Start: enter the value with -keys and confirm with .
 - Pressure range End: enter the value with -keys and confirm with .
 - Select the reference of the accuracy of the UUT with -keys and confirm with . ("FS"=of full scale value; "rd"=of actual reading)
 - Enter the accuracy class with -keys and confirm with .
 - Select pressure unit with -keys and confirm with  (return from sub-menus with .
 - Select type of measure (gauge / absolute) with -keys and confirm with .
 - Select pressure medium with -keys and confirm with  (Gas = gas/air; Oil = fluid).
 - Select PowerSupply to OFF with -keys and confirm with .
- ⑤ Press the -key a 2nd. time, now the working screen of the mode "MEASURING" is displayed.
- ⑥ Generate the requested test pressure with the connected pressure source (e.g. Calibration Handpump LPP 30). Look about the unit under test to adjust the test pressure.
- ⑦ Enter the test pressure with the -keys and confirm with .

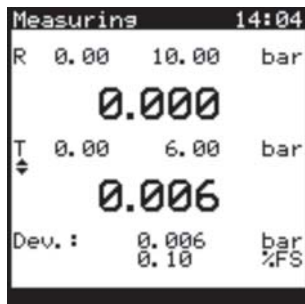

Now you see the set-value and the true value and the deviation of the unit under test in the selected pressure unit and in percentage (%FS or %rd, as selected). This allows an easy check whether the unit under test is within its specification or not.



DRUCK & TEMPERATUR Leitenberger GmbH

Bahnhofstr. 33 • D-72138 Kirchentellinsfurt • Germany • www.Leitenberger.com
 Tel. +49-7121-90920-0 • Fax +49-7121-90920-99 • E-Mail: DT-Export@Leitenberger.de



1. General Notes

This operating manual provides detailed information on the pressure calibrator LPC 300 and its proper use. In case of additional information required or problems occurring that are not treated in sufficient detail in this manual please contact:

DRUCK & TEMPERATUR Leitenberger GmbH
Bahnhofstr. 33 • D-72138 Kirchtellinsfurt • GERMANY
Tel. +49-7121-90920-0 • Fax +49-7121-90920-99
E-Mail: DT-Export@Leitenberger.de

The electronic pressure calibrator LPC 300 is delivered with calibration certificates. For the calibration of the LPC 300 and the certification international standards have been observed.

The warranty period for the electronic pressure calibrator LPC 300 is 24 months from the date of delivery. All guarantee claims expire in case of improper use, non-observance of the instruction manual or in case of any attempt to open the instrument.

We point out that the contents of this operating manual are neither part of a former or an existing agreement, commitment or legal relationship, nor does it constitute a modification.

All obligations arising for DRUCK & TEMPERATUR Leitenberger GmbH derive from the actual sales contract and the general terms of delivery and payment of DRUCK & TEMPERATUR Leitenberger GmbH only.

Company and product names mentioned in this operating manual are registered trade marks of these manufacturers.

We reserve the right of modifications in case of technical improvements.

1.1 General SAFETY notes



This instrument is built and inspected according to the safety regulations for electronic measurement devices. Function and operational safety of the instrument can only be guaranteed if national safety and accident prevention regulations and the safety guidelines in this manual are observed.

- The instrument LPC 300 may only be used by trained and authorized persons who know this manual and are able to work according to it.
- Faultless function and operating safety of the LPC 300 is only ensured under the climatic environment specified in the "Technical Data", see Chapter 11, Appendix, Page 29.
- The electronic pressure calibrator LPC 300 must always be handled with the care necessary for an electronic precision measurement device.
Do protect from moisture, shock, strong magnetic fields, static electricity and extreme temperatures.
Do not insert objects into the instrument or its openings!
The instrument and the reference sensor LPC-S must be handled with care (do not throw, drop, etc.). Plugs and sockets must be protected from dirt.
- When transporting the LPC 300 from a cold to warm environment a malfunction can occur in case of formation of condensation water. If so, the instrument must not be used again until the instrument temperature has adjusted to the room temperature.



- If the LPC 300 is to be connected to another device (e.g. via serial interface) take care when designing the equipment connections. It is possible that internal wiring within the external device (e.g. connection of GND to Earth) may cause excessive voltages which could harm or destroy the instrument or other connected devices.
- The mains plug of the power supply / battery charger unit powering the LPC 300 must always be accessible when connected to a power outlet, i.e. you must be able to pull the plug from the power outlet without difficulty, at any time. However if possible, for safety reasons, it should be operated without the battery charger attached.
- Significant electromagnetic radiation can adversely affect the measuring signal of the reference sensor (and therefore also the unit under test) or even disrupt the display of the signal completely.
- The display window is made of glass (which can shatter). Unless there is no possibility of this glass breaking during operation, anyone in the close vicinity of the equipment, must wear eye protectors, both before and during operation.
- Test and calibration assemblies must always be constructed and also dismantled in an unpressurised state (open to atmosphere).
- If the LPC 300 reference sensor LPC-S is used for applications with oil as the fluid media, then subsequent use with fuels or gases is prohibited, since this could cause an explosion and risks harm to both people and machinery.
If the equipment is damaged and might no longer operate safely, then it should be taken out of use and securely marked in such a way so that isn't used again.

Operator safety may be at risk if:

- there is visible damage to the device
- the device is not working as specified
- the device has been stored under unsuitable conditions for an extended period of time.

If there is any doubt, please return the device to DRUCK & TEMPERATUR Leitenberger GmbH for repair or maintenance.

- Customers must not attempt to alter or repair the device themselves. Please return the device to DRUCK & TEMPERATUR Leitenberger GmbH for any repair or maintenance.
- Any operation not included in the following instructions or outside the specifications must not be attempted.

1.2 SAFETY notes about LPC 300 chargeable battery



The electrolytes within the LPC 300's rechargeable batteries are inflammable. If there is any visible leakage, the equipment must be kept away from ignition sources and should be wrapped in absorbent cloths.

If there is any contact with this electrolyte it should be removed by rinsing thoroughly with clean water. If it comes into contact with the eyes: do not rub them. If it comes into contact with the skin - soap should also be used.

Medical assistance should be sought immediately!

In the case of fire, the incineration gases are irritating and poisonous. If this occurs, appropriate action must be taken and immediate medical assistance sought!



DRUCK & TEMPERATUR Leitenberger GmbH
Bahnhofstr. 33 • D-72138 Kirchentellinsfurt • Germany • www.Leitenberger.com
Tel. +49-7121-90920-0 • Fax +49-7121-90920-99 • E-Mail: DT-Export@Leitenberger.de



2. Charging the LPC 300 battery

The mains plug of the battery charger unit powering the LPC 300 must always be accessible when connected to a power outlet, i.e., you must be able to pull the plug from the power outlet without difficulty, at any time. However if possible, for safety reasons, it should be operated without the battery charger attached.



Use with a defective power supply unit (e.g. short-circuit from mains voltage to the output voltage) can produce lethal voltages within the equipment!

The LPC 300 is delivered with the batteries 25% to 50% charged and they should first be fully charged before initial operation. The battery level status (charge in %) is briefly indicated as the LPC 300 is switched ON, and/or it can be viewed via the SETUP-menu / LPC-Settings (see Chapter 10.5) during operation.

The ambient temperature during charging must be between 10°C and 45°C.



The battery level during storage or shipping should be between 30% and 50%.

- Only use the original battery charger supplied with the LPC 300.
- Make sure that the voltage of your main power outlet corresponds with the data printed on the label of the battery charger (see also Chapter 4, Pages 8 and 9).
- When the battery charger is not in use, its power supply plug should be disconnected from the mains socket. Do not leave the battery charger attached to the rechargeable battery longer than one day, since overloading can shorten its lifespan. If, after 24 hours, the rechargeable battery isn't fully charged, you should contact DRUCK & TEMPERATUR Leitenberger GmbH. When unused, a fully charged battery will lose its charge over time.
- Extreme temperatures have an adverse effect on battery charging. As a result, the battery may first need to be either cooled or warmed, as appropriate.
- When the battery is nearly empty, the message "low BAT" appears in the lower info display. With 0% battery level, the equipment automatically switches itself off and must then be recharged using the LPC 300 battery charger.
- Do not use a damaged or worn battery charger.
- Keep the equipment between 15°C and +35°C. Equipment with either a warm or cold battery might not operate fully.
- In particular, Li-Ion rechargeable batteries operate poorly under 0°C.

The battery may not be changed by the user. If in any time a change of the internal LPC 300 batteries is necessary, send the unit to:

DRUCK & TEMPERATUR Leitenberger GmbH
Service-Department
Bahnhofstr. 33
72138 Kirchentellinsfurt / GERMANY



3. Connecting a system reference sensor LPC-S to the LPC 300



Only the original Reference Sensors LPC-S (from DRUCK & TEMPERATUR Leitenberger GmbH may be connected to the LPC 300. Do not connect any other sensor to the LPC 300. This can damage the sensor and / or the LPC 300.

Switch off the LPC 300 before you change the reference sensor LPC-S. The LPC 300 must be switched off before dismantling or mounting a reference sensor LPC-S.

At the moment, when you switch on the LPC 300, the reference sensor LPC-S must be in the same mounting position like later when you calibrate with the system.

At the moment, when you switch on the LPC 300, the reference sensor LPC-S may not be pressurized (system open to ambient pressure).

For gauge-pressure sensors LPC-S, there is a pressure-equalising vent in the top of the sensor under the plastic fitting. This vent (with integrated membrane) must remain absolutely clear!

3.1 Mechanical connection of the reference sensor LPC-S

To fit the LPC 300 reference sensor LPC-S, it must be placed, connecting thread first, in the hexagonal sensor bracket of the LPC 300, so that the 6-sided anti-rotation stop of the LPC 300 sits accordingly in the sensor bracket. Subsequently, the sensor can be secured with the hand-operated quick-connect mechanism. (tighten = turn clockwise; release = turn anti-clockwise).

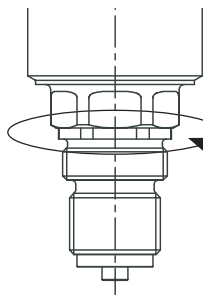

6-sided anti-rotation stop

Manual quick-connection enabling easy change of sensors

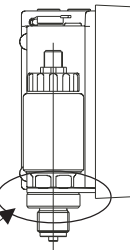

3.2 Electrical connection of the reference sensor LPC-S

3.2.1 Direct connection



connection cable for reference sensor LPC-S



The electrical connection of the reference sensor LPC-S to the LPC 300 is made via a M 12 x 1.5 circular connector with screw-locking. To connect a LPC-S reference sensor electrically, the connector on the sensor must be plugged together in accordance with the orientation guidance and should be secured by the screw collar (turn the screw collar clockwise without overtightening it). To disconnect, the screw collar must be turned anti-clockwise and the sensor pulled away using the connector body, not the cable.

**3.2.2 Connection using the optional extension cable
(external use of the reference sensor LPC-S with extension cable LPC-KABEL)**



Only the original extension cable from DRUCK & TEMPERATUR Leitenberger GmbH may be used (order-code: LPC-KABEL).
We recommend to use only one extension cable (extension length 1.1 m).

For disconnecting the electrical plug please follow the instructions in chapter 3.2.1



See also chapter 5.1 (Calibration Setup, Examples, Page 12)

4. Electrical Ports at the LPC 300

On the top of the LPC 300 housing all electrical connections are located:

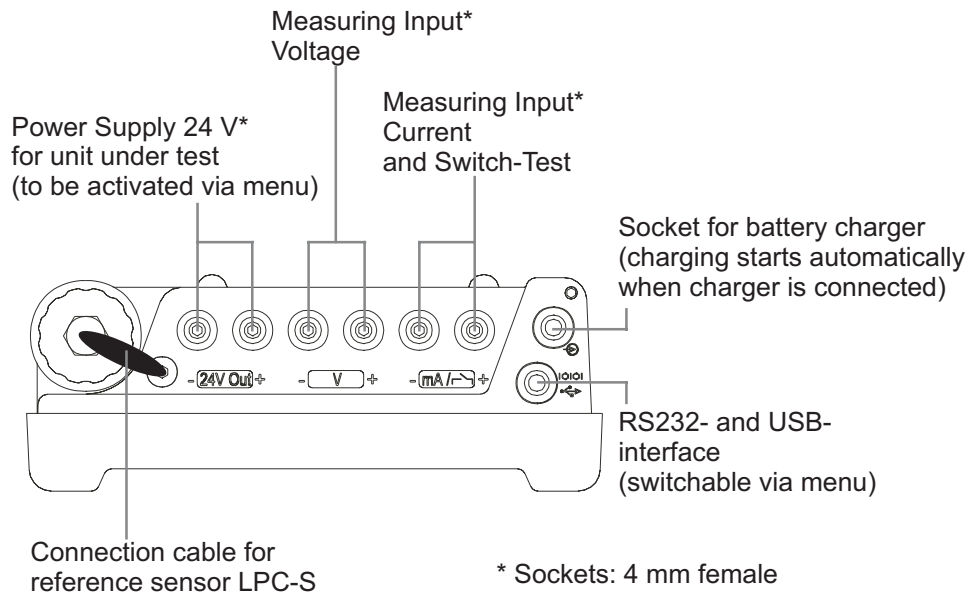



Only original LPC 300 accessory parts may be connected to the sockets of the LPC 300. Connect only LPC 300 battery charger to the charging socket; connect only the original measuring lines, supplied with the LPC 300, to the 4 mm measuring sockets.

During plug-in and plug-off of any connections, the LPC 300 must be switched OFF. Make sure, that your local mains voltage corresponds with the specification (see label) of the LPC 300 - battery charger.

The measuring inputs may not be electrical overloaded (see technical data in the addendum).

If the unit under test shall not be powered by the LPC 300's 24V-output, switch off the output via LPC 300 menu.

The 24V output of the LPC 300 may not be short-circuited.

The maximum output current (50 mA) may not be exceeded.

Also you should not under-run 20 mA to secure a correct measurement of current.



4.1 Electrical connection of a pressure switch (floating distance, as unit under test / UUT)



You may connect a passive pressure switch (floating distance) to the LPC 300 according to following scetch (use the supplied measuring cables). Do NOT supply with voltage or current, this can destroy your LPC 300.

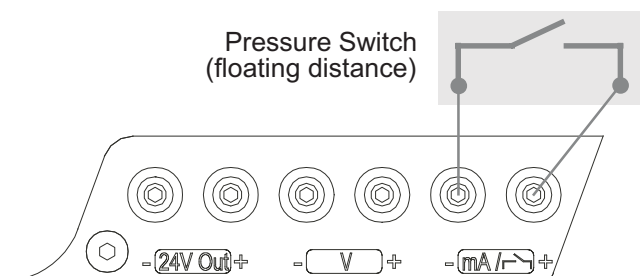

4.2 Electrical connection of a 2-wire pressure transmitter (as unit under test / UUT)

In the following description we assume that your unit under test is to be electrical connected as follows:

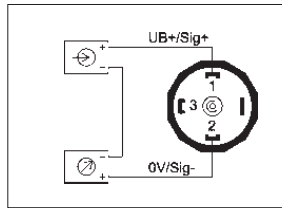

If the wiring scheme of your unit under test is different from above scetch, the following descriptions have to be adapted accordingly.

NOTES:

- If the LPC 300 is operated to read values of the test item, e.g. 0-1 V, 0-2 V, 0-5 V, 0-10 V, but no test item is connected, random values are shown in the display. This is no error, but happens due to the internal circuit of the measuring inputs of the LPC 300.
- If the unit under test is not powered by the LPC 300 but by an external power source, you have to consider that the measuring inputs of the LPC 300 have following internal resistance:
Input "Voltage": 24 KiloOhm
Input "Current": 200 Ohm
The external power source of the unit under test must be suitable to this additional need of power.

Unit under Test = Pressure Transmitter with signal output **mA (2-wire)**:

<p>The unit under test shall be powered by the 24 V output of the LPC 300. (24 V output must be activated via LPC 300 menu):</p>	<p>The unit under test shall be powered by external power source. (24 V output of the LPC 300 must be switched off via LPC 300 menu):</p>
--	---

Unit under Test = Pressure Transmitter with signal output **V (2-wire)**:

<p>The unit under test shall be powered by the 24 V output of the LPC 300. (24 V output must be activated via LPC 300 menu):</p>	<p>The unit under test shall be powered by external power source (24 V output of the LPC 300 must be switched off via LPC 300 menu):</p>
--	--



4.3 Electrical connection of a 3-wire pressure transmitter (as unit under test / UUT)

In the following description we assume that your unit under test is to be electrical connected as follows:

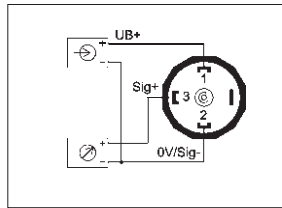

If the wiring scheme of your unit under test is different from above scetch, the following descriptions have to be adapted accordingly.

NOTES:

- If the LPC 300 is operated to read values of the test item, e.g. 0-1 V, 0-2 V, 0-5 V, 0-10 V, but no test item is connected, random values are shown in the display. This is no error, but happens due to the internal circuit of the measuring inputs of the LPC 300.
- If the unit under test is not powered by the LPC 300 but by an external power source, you have to consider that the measuring inputs of the LPC 300 have following internal resistance:
Input "Voltage": 24 KiloOhm
Input "Current": 200 Ohm
The external power source of the unit under must be suitable to this additional need of power.

Unit under Test = Pressure Transmitter with signal output **mA (3-wire)**:

<p>The unit under test shall be powered by the 24 V output of the LPC 300. (24 V output must be activated via LPC 300 menu):</p>	<p>The unit under test shall be powered by external power source. (24 V output of the LPC 300 must be switched off via LPC 300 menu):</p>
--	---

Unit under Test = Pressure Transmitter with signal output **V (3-wire)**:

<p>The unit under test shall be powered by the 24 V output of the LPC 300. (24 V output must be activated via LPC 300 menu):</p>	<p>The unit under test shall be powered by external power source. (24 V output of the LPC 300 must be switched off via LPC 300 menu):</p>
--	---



5. Calibration Setup

5.1 Examples

As standard, the reference sensor LPC-S is mounted to the LPC 300 unit:

Calibration Setup with Calibration Handpump as pressure source



Calibration Setup with Pressure Comparator (spindle pump) as pressure source

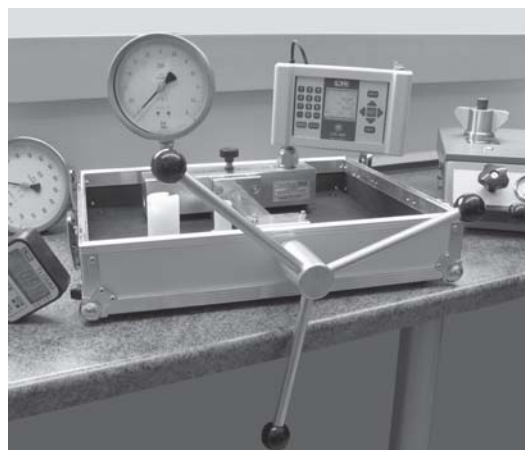

With the optional extension cable (order-code LPC-KABEL, length appr. 1.1 m) the reference sensor LPC-S can be used "external", e.g. mounted directly on the pressure source, the LPC 300 can be placed separately, e.g. on a table:

Calibration Setup with Calibration Handpump as pressure source with **external** connected reference sensor



5.2 Standards for Calibration Setups with the LPC 300



Before you start working with the LPC 300, check the battery capacity. The capacity is shown on the status- (info-) screen for a short duration after switching on the LPC 300 (see Chapter 8.1, Page 13). At capacity of 100% you can work for about 8 hours without charging.

First, build up the calibration setup (mechanical and electrical connections) according the corresponding Chapters in this manual .

Make sure that the calibration circuit is not pressurised (must be open to atmosphere) before you switch on the LPC 300. The reference sensor LPC-S should be in the same mounting position as later during calibration.



Especially low pressure ranges are sensitive to the mounting position. This means, the mounting position can affect the measuring signal!

- Zero adjustment of the reference sensor LPC-S (not for absolute pressure types):
If the calibration circuit is vented to the atmosphere and the LPC 300 display does not show 0 (zero) value for the reference sensor, you can set to 0 (zero) by pressing the  -key **twice**.
- Compensation of difference of level (niveau):
If there is a difference of level between the reference sensor LPC-S and your unit under test, this medium column causes a deviation of pressure reading. To compensate this level difference, you can enter (in mm) the niveau in the LPC 300 setup (Chapter 10.5: SETUP / "LPC-Configuration", Page 27 and Chapter 8.1: status screen, Page 16)
- Date of Calibration (of unit under test):
The LPC 300 is featured with an integrated real time clock. The date of calibration of your unit under test should be stated on your calibration certificate. Please check that the date and time settings of your LPC 300 are proper.
Note: you use this functionality only in operation mode CALIBRATION and if you upload the calibration data to a PC with the optional software "LPC-Cal", see Page 28.
For the settings, see Chapter 10.5: SETUP / LPC-Configuration, Page 27 and also Chapter 8.2.2 (screens of operating mode CALIBRATION), Page 18.
- Ambient temperature during calibration:
If you create calibration certificates, you should also state the ambient temperature during the calibration procedure. You can enter the temperature at the LPC 300 for later uploading to a PC.
Note: you use this functionality only in operation mode CALIBRATION and if you upload the calibration data to a PC with the optional software "LPC-Cal", see Page 28.
For the settings, see Chapter 10.5: SETUP / LPC Configuration, Page 27 and also Chapter 8.2.2 (screens of operating mode CALIBRATION), Page 18.

NOTE:

When supplied, the LPC 300 shows pressure in unit "bar".
You can switch to other pressure units, please read the notes on page 29.



DRUCK & TEMPERATUR Leitenberger GmbH

Bahnhofstr. 33 • D-72138 Kirchentellinsfurt • Germany • www.Leitenberger.com
Tel. +49-7121-90920-0 • Fax +49-7121-90920-99 • E-Mail: DT-Export@Leitenberger.de



6. User interface

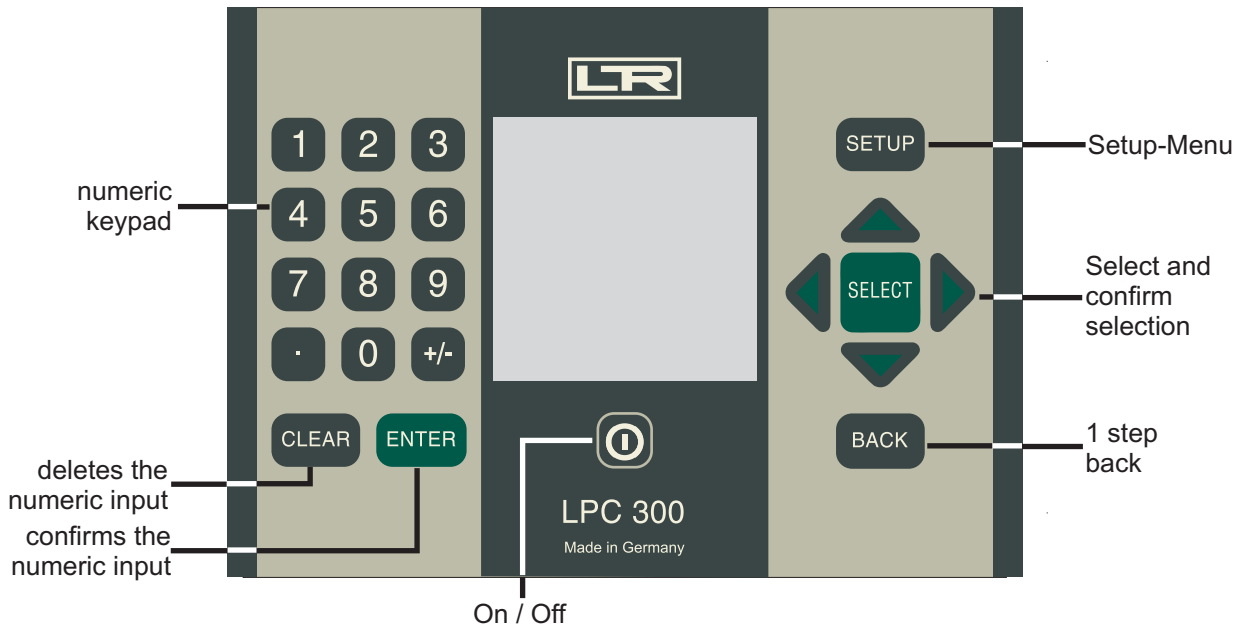

6.1 General usage notes:

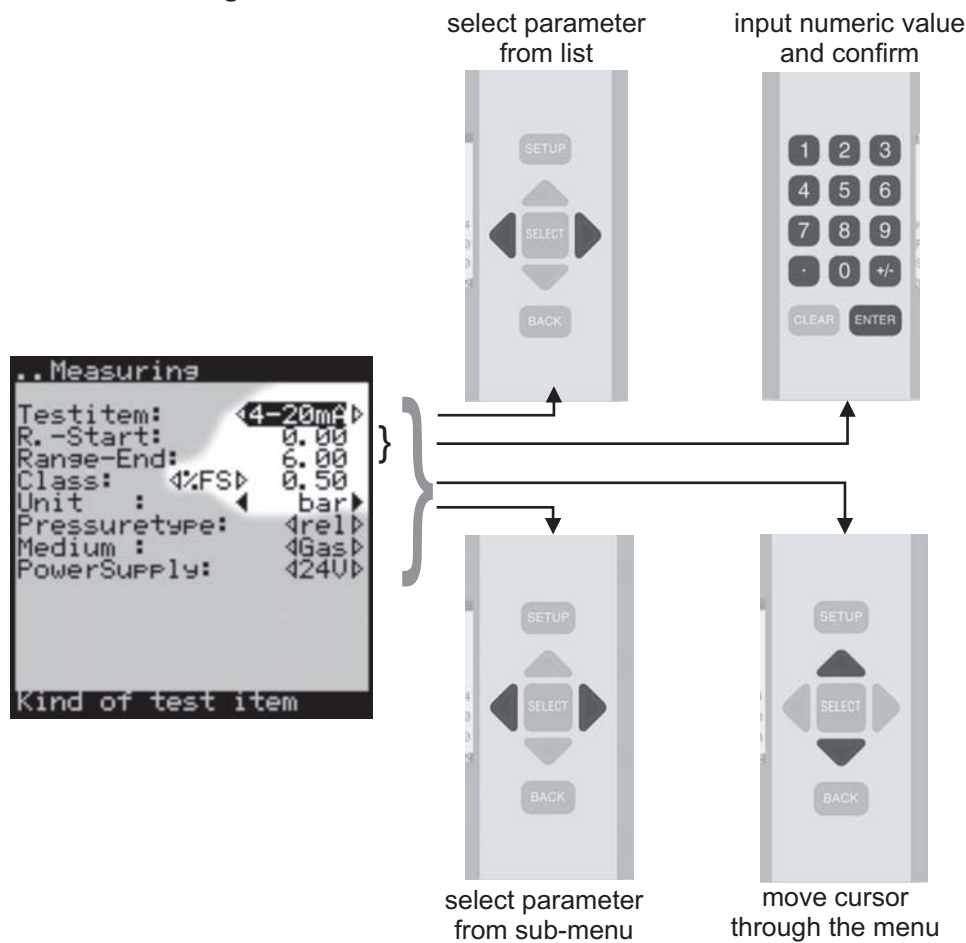

7. Menu structure (Operating Modes)

The LPC 300 has three different operating modes: MEASURING • CALIBRATION • SWITCH-TEST

Mode	Application (Examples)	
MEASURING Chapter 8.2.1 Page 17 and Chapter 9.1 and 9.2 Pages 20+21	LPC 300 as simple pressure indicator (without unit under test)	Measure pressure and calibrate, without documentation (resp. documentation by hand) e.g. check the accuracy of an unit under test without pre-defined calibration procedure and without generating calibration certificate with PC. If you first specify the unit under test in the LPC 300, the reading error of the unit under test ist calculated and displayed on the LPC 300 screen.
CALIBRATION Chapter 8.2.2 Page 18 and Chapter 9.3 Page 22	Pre-define calibration procedures and work with them. Upload of the calibration data to PC possible with optional software "LPC-Calc"	
SWITCH-TEST Chapter 8.2.3 Page 18 and Chapter 9.4 Page 24	Check and adjust switch point of pressure switches Hysteresis is calculated and displayed on the LPC 300 screen	

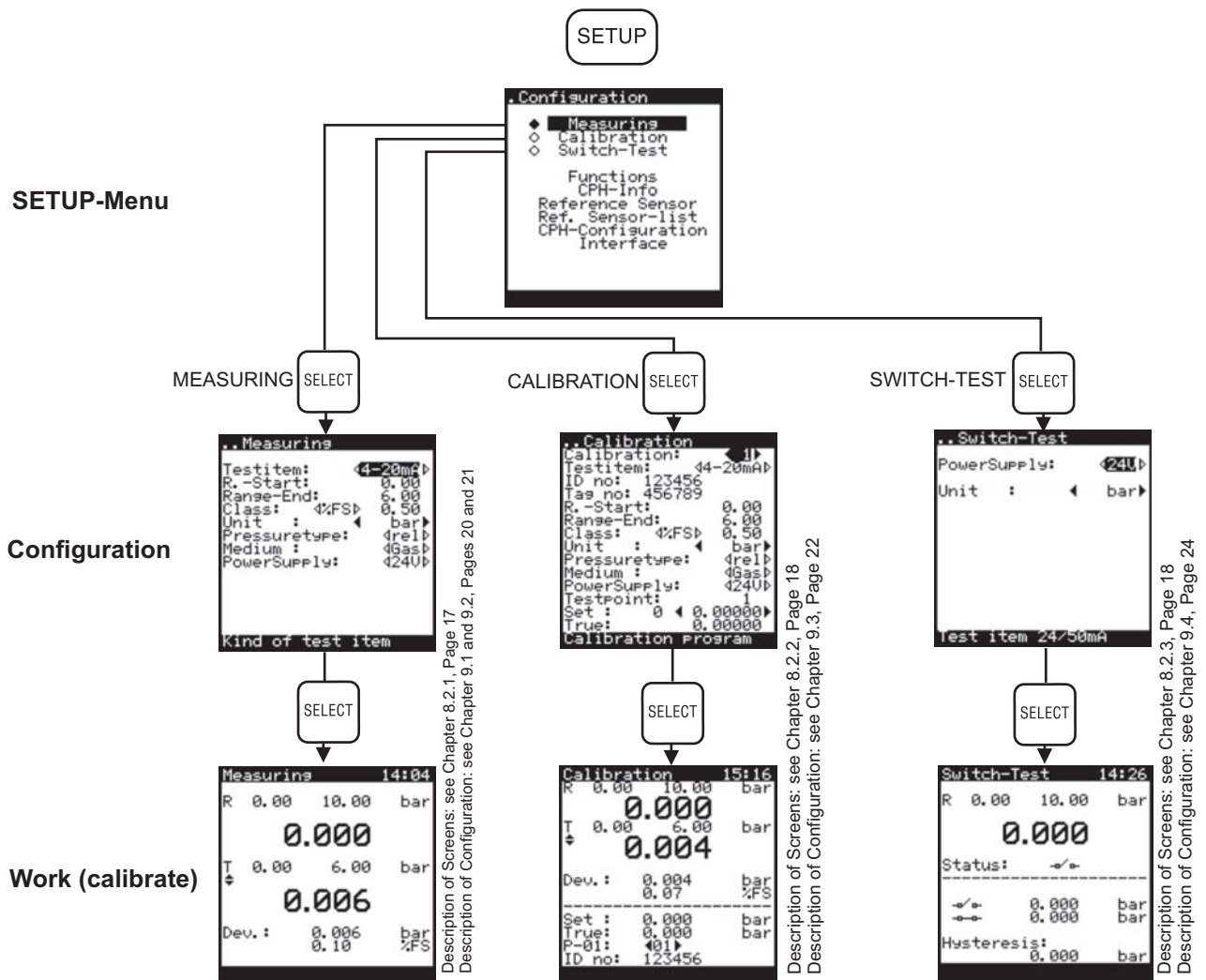

The reading values of the unit under test can be switched from "pressure" to "electrical signal" with -keys.



8. Screen displays

8.1 State screen (INFO screen, after Switch-On of the LPC 300)

Immediately after switching on the LPC 300 unit, the State (Info) screen is displayed for a short time:

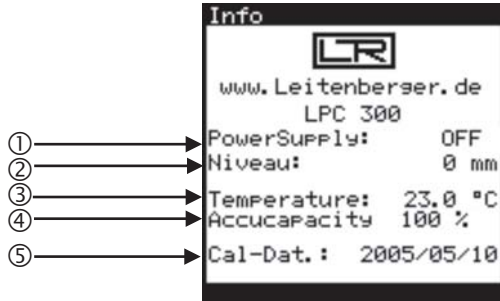

Meaning of the displayed screen lines:

- ① The 24V output for powering the unit under test (24 V) can be selected if you configure the requested operating mode. Here you can see if the 24V output is switched ON or OFF.
If you do not need to source the unit under test with 24V, please select OFF to save battery power.
- ② Niveau [mm]:
Here you can see the value, which had been entered at last usage of your LPC 300. The "Niveau" value is the difference in height between unit under test and reference sensor LPC-S. Such a difference results in an additional pressure difference, caused by medium column (air/water/oil-column). This value must be entered correct, otherwise you get wrong results.
In case of doubt, enter 0 (zero).
Entering the niveau value: see Chapter 10.5, Page 27.
- ③ Temperature [°C/°F]:
Here you see the temperature value, which had been entered in the menu "SETUP \ LPC-Configuration" as ambient temperature during your calibration. In operating mode CALIBRATION and when using the optional PC-software "LPC-Cal" (see info on page 28), this value is uploaded to the PC. It will be printed on the calibration certificate, generated by the software LPC-Cal.
The temperature must be measured with a (precise) thermometer and entered acc. to Chapter 10.5 (SETUP \ LPC-Configuration) on page 27.
- ④ Actual capacity of the LPC 300 battery (in percentage). With 100% capacity you can work about 8 hours "unplugged". Please charge the LPC 300 battery early enough.
- ⑤ Act-Dat: Actual Date according to the settings of the real time clock of your LPC 300.
Cal-Dat: Date of calibration of the electrical measuring inputs of the LPC 300.

After a short time the status screen disappears and the working screen of the last used operating screen is displayed. See next Chapter 8.2, page 17 ff.



DRUCK & TEMPERATUR Leitenberger GmbH

Bahnhofstr. 33 • D-72138 Kirchentellinsfurt • Germany • www.Leitenberger.com
Tel. +49-7121-90920-0 • Fax +49-7121-90920-99 • E-Mail: DT-Export@Leitenberger.de



8.2 Screens of the three operating modes

8.2.1 Operating mode MEASURING

After the first Switch-On of a new LPC 300 with connected reference sensor LPC-S, the working screen of the operating mode MEASURING is displayed (after short display of the status screen, see Chapter 8.1, Page 16):

Screen: MEASURING without unit under test, LPC 300 as pressure indicator:

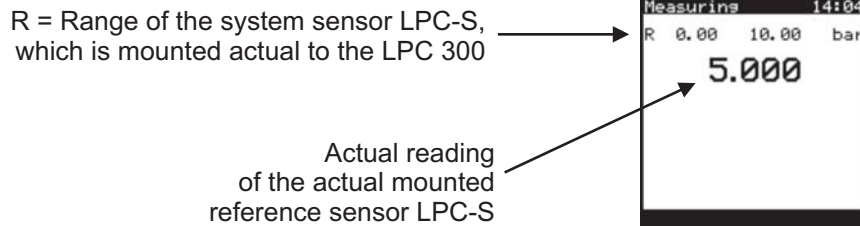

(Description of operating mode MEASURING without connected unit under test: see Chapter 9.1, Page 20)

In mode MEASURING, there can be displayed also the pressure value of a connected unit under test:

Screen: MEASURING with unit under test:

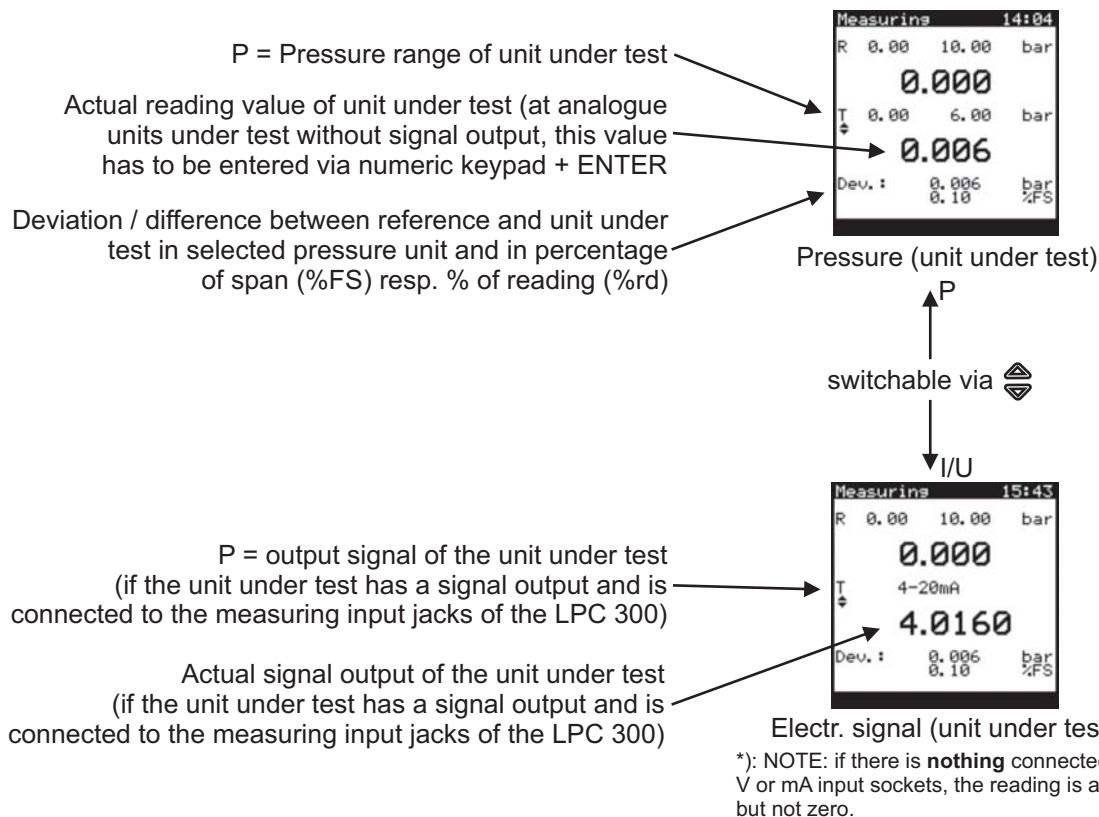

(Description of operating mode MEASURING with connected unit under test: see Chapter 9.2, Page 21)



8.2.2 Operating mode CALIBRATION

In operating mode CALIBRATION the data on the screen above the dashed line is the same like in operating mode MEASURING; see Chapter 8.2, Page 17.

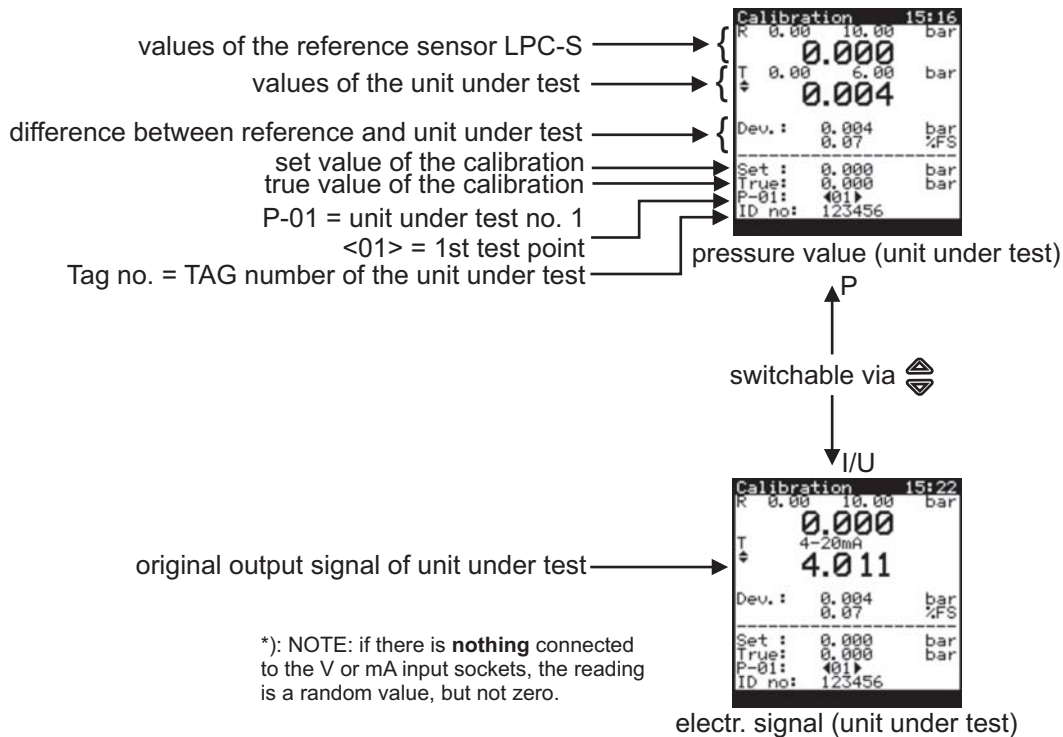

(Description of operating mode CALIBRATION: see Chapter 9.3, Page 22)

8.2.3 Operating mode SWITCH-TEST

In operating mode SWITCH TEST the values of the reference sensor are displayed (see operating mode MEASURING) together with actual state and switch-points of a pressure switch, connected as unit under test:

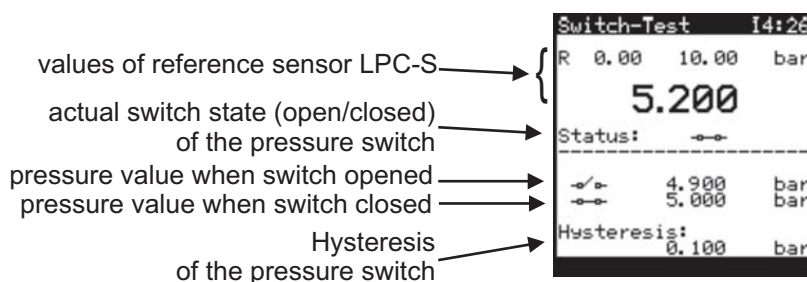

(Description of operating mode SWITCH TEST: see Chapter 9.4, Page 24)



8.3 SETUP-Menu (settings)

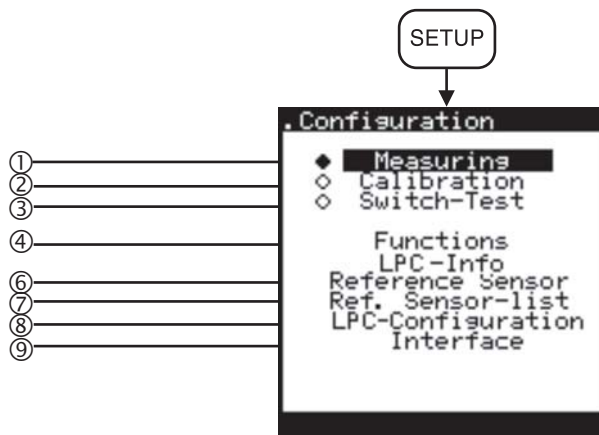

NEW:
last menu item CLEAR CalProg:
Selecting this menu item, all
calibration data, stored in the LPC
300 will be deleted.





- ① **MEASURING:** operating mode MEASURING (see Chapter 9.1)
 - to measure a process pressure
 - to calibrate (without storage of the calibration data) analogue and electronic pressure gauges (transmitters can be powered by LPC 300, output signal can be displayed).
- ② **CALIBRATION:** operating mode CALIBRATION (see Chapter 9.3)
 - to calibrate analogue and electronic pressure gauges. Calibration procedures can be pre-defined. Predefined calibration procedures can be executed (e.g. in the field). The data is saved in the LPC 300 memory, incl. date and time. Results can be uploaded to a PC with the optional PC software "LPC-Cal" (see info on page 28).
- ③ **SWITCH-TEST:** operating mode SWITCH-TEST (see Chapter 9.4)
 - to check and adjust the switch points of passive pressure switches (floating distance), with automatic calculation of the hysteresis.
- ④ **Functions:** Here you can adjust several functions of the LPC 300 (see Chapter 10.1)
 - Tara = offset value of the reference sensor LPC-S
 - Min/Max = Minimum-/Maximum value storage
 - Alarm = High-/Low-Alarm (visual and acoustic)
- ⑥ **Reference Sensor:** Data of the actual connected reference sensor LPC-S. (see Chapter 10.3)
 - Pressure range, Accuracy class, Pressure type, Overload, calibration date
- ⑦ **Ref. Sensor-list:** List of reference sensors LPC-S (see Chapter 10.4)
 - List of those reference sensors LPC-S, whose calibration data is stored in your LPC 300 memory.
- ⑧ **LPC-Configuration:** Settings of your LPC 300 (see Chapter 10.5)
 - Capacity of the LPC 300 battery [%]
 - Setting of the menu language, date, time, display brightness, powersave function
 - Possibility to enter ambient temperature and niveau (niveau difference between reference sensor and unit under test. (see Chapter 5.2)
- ⑨ **Interface:** USB- and RS232 settings (see Chapter 10.6)
 - choose USB or RS232
 - set baud rate for RS232

(Description of the functions see Chapter 10, Page 25 ff)









9. Operating modes

In Chapter 7 (Page 15) you have learned about the menu structure, and also how to enter one of the three operating modes of your LPC 300. Summary:

- Enter Setup menu by pressing , move cursor with  to the requested operating mode and confirm with .
- Now the configuration screen of the selected operating mode is displayed.
- Enter data / make selections acc. to following description and press  over again.
- Now the working screen of the selected operating mode is displayed.

Basic instructions for entering data or selecting values:

- **Fields where you SELECT data** you can identify by the triangle symbols before and behind the field: The symbols ◀ and ▶ mean: make your selection with -keys and confirm with . The symbols ◀ and ▶ mean: after pressing one of the -keys, a sub-menu is displayed. Go back from a sub menu with the -key.
- **Fields where you ENTER data** you can identify by missing triangle symbols. Enter the values with the numeric keypad (delete with CLEAR) and confirm with .
- The cursor can be moved with the -key and confirm with -key.

9.1 Operating mode MEASURING - without unit under test (use LPC 300 as pressure indicator)

Configuration screen of the operating mode MEASURING:



- "Testitem:" choose the four dashes "----"
- "R-Start:" (do not enter here something)
- "Range-End:" (do not enter here something)
- "Class : " (do not enter here something)
- "Unit:" select requested pressure unit and display resolution *)
- "Pressuretype:" (do not enter here something)
- "Medium : " (do not enter here something)
- "PowerSupply:" select "OFF"

Afterwards press the -key again; now the working screen is displayed:

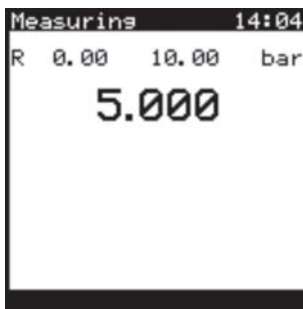



Description of the LPC 300 screens see also Chapter 8.2.1, Page 17.

*) **Sub-menu "Unit" (pressure unit):**
Here you choose the requested pressure unit, also the requested LPC 300 display resolution is selected here:

Select and confirm with 

User = userdefined unit, related to "bar"

Adjust display resolution with 

Confirm with  **Read the NOTE on page 29!**



9.2 Operating mode MEASURING - with unit under test (calibration without documentation)

Configuration screen of the operating mode MEASURING:



- "Testitem:" Choose type of item under test resp. output signal:
 "mechan" = analogue (e.g. pressure gauge)
 "0-20mA" = Pressure transmitter output 0...20 mA
 "4-20mA" = Pressure transmitter output 4...20 mA
 "0-1 V" = Pressure transmitter output 0...1 V
 "0-5 V" = Pressure transmitter output 0...5 V
 "0-10V" = Pressure transmitter output 0...10 V
- "R-Start:" Pressure range (start)
- "Range-End:" Pressure range (end)
- "Class:" %FS = accuracy is based on span (full scale)
 %rd = accuracy is based on reading value
 enter accuracy class (in %)
- "Unit": select requested pressure unit and display resolution *)
- "Pressuretype:" Measuring method: gauge (rel) or absolute (abs)
 gauge = measures difference to ambient pressure
 absolute = measures difference to absolute zero
- "Medium:" Gas = gaseous medium (air, nitrogen, etc.)
 Oil = fluid medium (oil, water, etc.)
- "PowerSupply:" OFF = no power supply 24V for unit under test
 24V = power supply for unit under test = on.

Afterwards press the -key again; now the working screen is displayed:

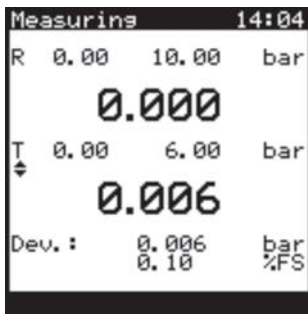

pressure value (unit under test)

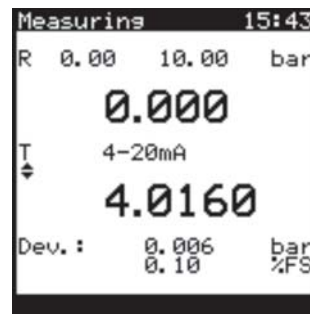
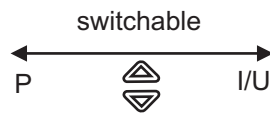

electrical signal (unit under test)

*) : NOTE: if there is **nothing** connected to the V or mA input sockets, the reading is a random value, but not zero.

Description of the LPC 300 screens see also Chapter 8.2.1, Page 17.

NOTE:
If the unit under test is an analogue instrument without signal output, you must enter the reading values from the unit under test with the numeric keypad.

0000
0000
0000
0000

Confirm with

*) **Sub-menu "Unit" (pressure unit):**
Here you choose the requested pressure unit, also the requested LPC 300 display resolution is selected here:

Select and confirm with

User = userdefined unit, related to "bar"

Adjust display resolution with

Confirm with **Read the NOTE on page 29!**



9.3 Operating mode CALIBRATION

Before you start in operating mode CALIBRATION, you have to pre-define your calibrating procedure(s). You can prepare up to 16 procedures with each max. 32 pressure steps in the memory of your LPC 300.

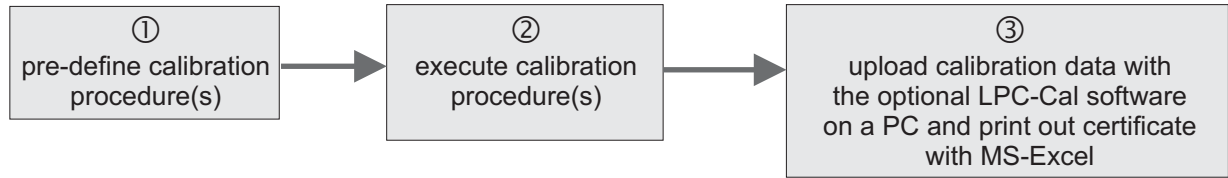

① Configuration screen of the operating mode CALIBRATION:



- "Calibration:" Calibration procedure (program) number (1...16 possible).
- "Testitem:" Choose type of item under test resp. output signal:
 "mechan" = analogue (e.g. pressure gauge)
 "0-20 mA" = Pressure transmitter output 0...20 mA
 "4-20 mA" = Pressure transmitter output 4...20 mA
 "0-1 V" = Pressure transmitter output 0...1 V
 "0-5 V" = Pressure transmitter output 0...5 V
 "0-10 V" = Pressure transmitter output 0...10 V
- "ID no.:" Identification number (serial no.) of item under test
- "Tag no.:" TAG-number of item under test
- "R-Start.:" Pressure range (start)
- "Range-End.:" Pressure range (end)
- "Class.:" %FS = accuracy is based on span (full scale)
 %rd = accuracy is based on reading value
 enter accuracy class (in %)
- "Unit.:" select requested pressure unit and display resolution *)
- "Pressure type.:" Measuring method: gauge (rel) or absolute (abs)
 gauge = measures difference to ambient pressure
 absolute = measures difference to absolute zero
- "Medium.:" Gas = gaseous medium (air, nitrogen, etc.)
 Oil = fluid medium (oil, water, etc.)
- "PowerSupply.:" OFF = now power supply 24V for unit under test
 24V = power supply for unit under test = on
- "TestPoint.:" Consecutively numbered test point (1...32 possible)
 First test point = "1", second test point = "2", etc. etc..
- "Set.:" Input field (3 digits) to enter a dwell time (in seconds)-
 The dwell time (between 0 and 999 seconds) allows a calibration according to DKD directive. A value > 0 means that the reading value can be overtaken resp. entered after expiry of the dwell time.
 Aside please enter the set point pressure (in the selected pressure unit. First set point should always be 0 (zero).
- "True.:" (during configuration, you cannot enter here a value)





If you like to calibrate according to the DKD directive, a dwell time should be maintained between each test point.

For pressure transmitters a dwell time of 2 min. (120 sec.), for analogue pressure gauges a dwell time of 5 min. (300 sec.) is recommended.

When you have entered the value of the 1st. test point, move the cursor one line up to "TestPoint" and switch (with cursor-keys) to the 2nd. TestPoint, enter dwell time (if required), enter pressure value of this 2nd. TestPoint and so on. If you enter NOTHING at "Set" (keep field empty), this shows to the LPC 300 that there are no more test points wanted in this calibration procedure.

Whenever you like you can leaf through the already defined test points with the ⏪ ⏩ -keys.



When you are ready with the defining of the calibration procedure(s), press again the  -key. Now the working screen of the operation mode CALIBRATION is displayed, with that procedure which you defined last. Example: you did define 5 different calibration procedures and now you want to execute the 2nd one. Go to the configuration screen of the CALIBRATION mode and choose there the 2nd. procedure. Press  and you can execute it.

② Working screen of the operating mode CALIBRATION:



pressure value (unit under test)

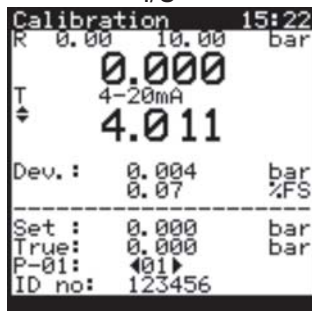
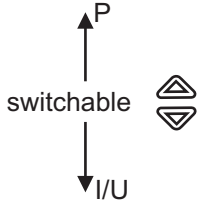

electrical signal (unit under test)

Above the dashed line, the content is the same like in operation mode MEASURING (with unit under test).

Below the dashed line:

"Set:" Test point pressure value.

If the set point is 0 (zero) the calibration setup must be vented to the atmosphere. If your unit under test is a digital instrument, set it to 0 (zero).

If the LPC 300 does not show 0 (zero), press the  key to set it to 0 (zero).

"True:" If you calibrate an instrument without signal output:

Adjust the test pressure **exactly** acc. to the test item and press .

If you calibrate a pressure transmitter which is electrical connected with the LPC 300, accept (confirm) the output by pressing  -key.

"P-0x:" Number of calibration procedure ("P-01" = procedure no. 1, etc.)

Aside the consecutively numbered actual test point is displayed. (e.g. <01> means "Test Point No. 1")

"ID no" Identification-Number (serial no.) of the unit under test

After your confirmation of the true value with the  -key, the next test point of the calibration procedure is displayed.

With the  -key you can go one step backward.

*) NOTE: if there is **nothing** connected to the V or mA input sockets, the reading is a random value, but not zero.

Description of the LPC 300 screens: see also Chapter 8.2.2, Page 18.

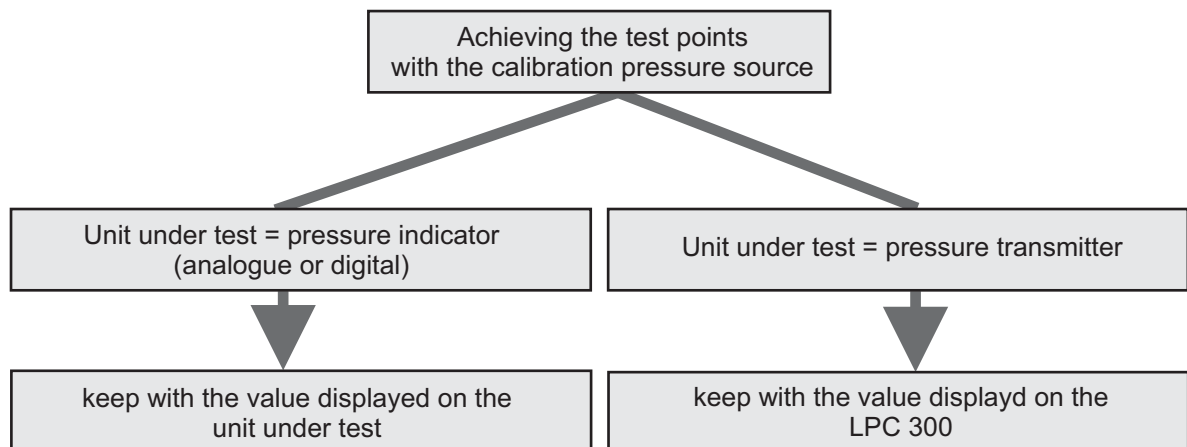

DRUCK & TEMPERATUR Leitenberger GmbH

Bahnhofstr. 33 • D-72138 Kirchentellinsfurt • Germany • www.Leitenberger.com
Tel. +49-7121-90920-0 • Fax +49-7121-90920-99 • E-Mail: DT-Export@Leitenberger.de



9.4 Operating mode SWITCH-TEST

Configuration screen of the operating mode SWITCH-TEST:



"PowerSupply:" If the unit under test (pressure switch) shall be powered by the LPC 300, set to "24V". Otherwise set to "OFF" to safe battery power.
"Unit:" select requested pressure unit and display resolution *)

Afterwards press the -key again; now the working screen is displayed:

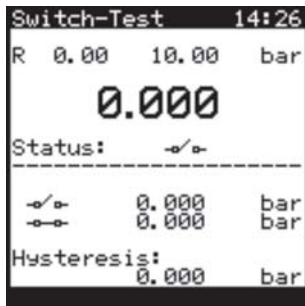

before the switch test

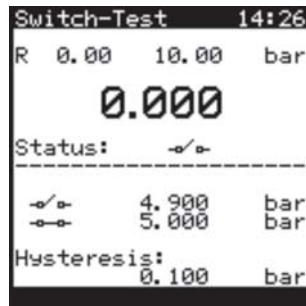

after the switch test

Description of the LPC 300 screens: see also Chapter 8.2.3, Page 18.

*) **Sub-menu "Unit" (pressure unit):**
Here you choose the requested pressure unit, also the requested LPC 300 display resolution is selected here:

Select and confirm with 

User = userdefined unit, related to "bar"

Adjust display resolution with 

Confirm with  **Read the NOTE on page 29!**



10. SETUP-Menu

Basic instructions for entering data or selecting values:

- **Fields where you SELECT data** you can identify by the triangle symbols before and behind the field: The symbols ◀ and ▶ mean: make your selection with ◀▶ -keys and confirm with . The symbols ◀ and ▶ mean: after pressing one of the ◀▶ -keys, a sub-menu is displayed. Go back from a sub menu with the -key.
- **Fields where you ENTER data** you can identify by missing triangle symbols. Enter the values with the numeric keypad (delete with CLEAR) and confirm with .
- The cursor can be moved with the -key and confirm with -key.

10.1 Menu "Functions"



- ① **Ref.**
Actual pressure reading of the connected reference sensor LPC-S.
- ② **Tara:**
Offset value to manipulate the actual reading of the reference sensor. The entered value will be added to the actual reading of the reference sensor.
(Example: Reading value = 10,000 and Tara = 5,000; the value 15,000 will be displayed as reference value.)
- ③ **Min: / Max:**
Minimum value storage and maximum value storage.
You can reset this memory by placing the cursor with on the Min. resp. Max. value and then pressing the -key.
- ④ **Alarm:**
Here you can switch on or switch off the visual and acoustic alarm of the LPC 300.
Enter the High alarm value behind ">=".
Enter the Low alarm value behind "<=".
As soon as the actual pressure reading of the LPC-S system sensor is above or below the alarm values, you can hear an acoustic alarm tone and the status line (last line on the screen) is flashing.
To switch on the alarm function select Alarm = ON;
to switch off the alarm function select Alarm = OFF.



10.2 Menu "LPC-Info"



Here you get information about your LPC 300:

- ① **Cal-Dat.:**
Date of calibration of the electrical measuring inputs of your LPC 300.
- ② **Firmware:**
Version number of the operating system of your LPC 300.
- ③ **SerialNo:**
Serial number of your LPC 300 (do not confound with the serial no. of the reference sensor LPC-S)

10.3 Menu "Reference Sensor"

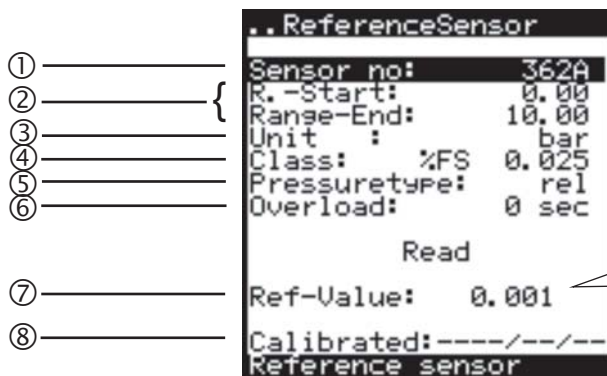

If a LPC-S reference sensor with **absolute** pressure range is used, an offset correction of the measured absolute (ambient) pressure is possible here, if you enter manually the pressure value which should be displayed as ambient pressure.

- ① **Sensor no:**
Sensor number of the actual connected reference sensor LPC-S (4 alphanumeric digits; do not confound with the serial number of the LPC-S, which you can find on the label and in the calibration certificate). The sensor number is marked at the hexagon connection of the LPC-S.
- ② **R.-Start: / Range-End:** Pressure range start & end of the actual connected ref. sensor LPC-S.
- ③ **Unit:** Basic pressure unit of the actual connected reference sensor LPC-S.
- ④ **Class:** Accuracy class (total uncertainty) of the calibration system consisting of LPC-300 with connected reference sensor LPC-S.
- ⑤ **Pressuretype:** Type of measurement of the actual connected reference sensor LPC-S: gauge (rel) or absolute (abs).
- ⑥ **Overload:** Period (sec.) where the actual connected reference sensor LPC-S had been overloaded. If this value is <> 0, a recalibration is recommended.
- ⑦ **Ref-Value:** Actual reading of the actual connected reference sensor LPC-S.
- ⑧ **Calibrated:** Date of last calibration of the actual connected reference sensor LPC-S.



10.4 Menu "Ref. Sensor-list"

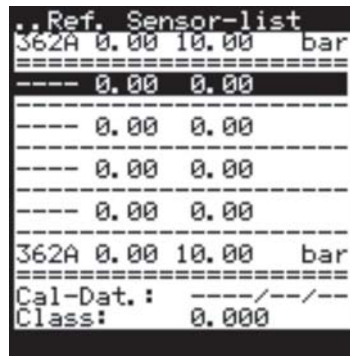

Select a listed referense sensor with the -keys.

(to get Info about date of calibration and accuracy class, see ③)

- ① Sensor number, pressure range start & end and pressure unit of the acutal connected reference sensor LPC-S.
- ② List of all reference sensors which are supported by your LPC 300. If you bought only one LPC-S sensor with your LPC 300, only one item is in this list. The memory of the LPC 300 can store the calibration data of up to five reference sensors LPC-S. Im LPC 300 steht Speicherplatz für bis zu fünf System-Referenzsensoren zur Verfügung.
- ③ Date of calibration and accuracy class of the highlighted reference sensor LPC-S.

10.5 Menu LPC-Configuration

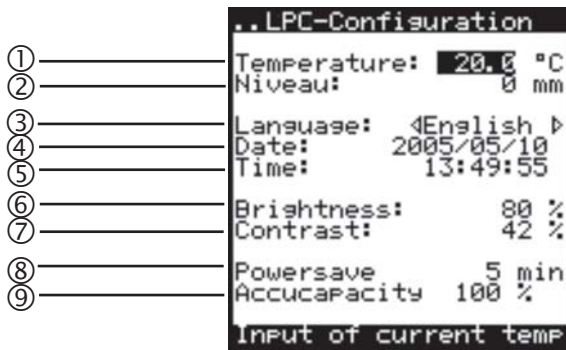

- select menu item with
- select entry with
- confirm selection with
- enter value with
- confirm entered value with
- delete input field with

- ① **Temperature:** Here you can enter the ambient temperature during your calibration work. This value is necessary only in operating mode CALIBRATION, together with optional PC-software LPC-Cal (the ambient temperature is uploaded to the PC to be printed on your calibration certificate). *)
- ② **Niveau:** Here you can enter a niveau difference between unit under test and reference sensor LPC-S for an automatic correction of the medium collumn. *)
- ③ **Language:** Select the requested LPC 300 menu language. **Wait 3 seconds after changing language.**
- ④ **Date:** Here you can set / correct the date of the integrated real time clock of your LPC 300. *)
- ⑤ **Time:** Here you can set / correct the time of the integrated real time clock of your LPC 300. *)
- ⑥ **Brightness:** Brightness of the display (we recommend a value between 75% and 100%).
- ⑦ **Contrast:** Contrast of the display (can be changed max. +2% and -2%).
- ⑧ **Powersave:** Here you can enter a duration (minutes). After this duration the display-backlight and the 24V-output are automatically switched off (press any key to switch on again).
- ⑨ **Accucapacity** Indication of the battery capacity [%]. We recommend to recharge the battery latest, if the percent value is <30%.

*) see also Chapter 5.2: Standards for calibration setups, Page 13.



10.6 Menu "Interface"



Here you can select the interface for the optional communication with a PC (with the optional software LPC-Cal).

The actual selected entry is marked with an arrow → .

If you've selected "RS232" as requested interface, you can select the baud rate. The other RS 232-parameters are always 8 data bits, no parity and 1 stop bit.

This selection is necessary only if you work in operating mode CALIBRATION together with the optional software LPC-Cal for uploading the calibration data to a PC and printing out certificates with MS-Excel.

Product Info: **LPC-Cal** for Microsoft Windows

System requirements:

Operating system Microsoft Windows 98 SE, 2000, XP Home, XP Professional
CD-ROM drive, color display, mouse, keyboard

Interface RS232 or USB available

Installed Microsoft EXCEL Version 97, 2000, XP or 2003

In addition, following LPC 300 accessory is required:

Order-Code LPC300-SW-RS232: Software LPC-Cal with RS232-interface cable for LPC 300

or

Order-Code LPC300-SW-USB: Software LPC-Cal with USB-interface cable (with driver) for LPC 300

or

Order-Code LPC300-SW-RS-USB: Software LPC-Cal with both above mentioned cables.

Instructions regarding the software LPC-Cal: see page 31



DRUCK & TEMPERATUR Leitenberger GmbH

Bahnhofstr. 33 • D-72138 Kirchentellinsfurt • Germany • www.Leitenberger.com
Tel. +49-7121-90920-0 • Fax +49-7121-90920-99 • E-Mail: DT-Export@Leitenberger.de



11. ADDENDUM - Technical Data

Accuracy (total uncertainty) LPC 300 with reference sensor LPC-S: $\pm 0.025\%$ of full scale value *)

Overpressure warning: audiovisual

Compensated temperature range: 0...50°C (active compensation)

Wetted parts of the reference sensor LPC-S: Stainless steel, complete welded

Display resolution: adjustable, max. 6 digits + leading sign + decimal point

Voltage measurement: 0-10 V, 0-5 V, 0-1 V. Resolution: display x 0,1 mV, Accuracy $\pm 0,5$ mV

Current measurement: 0-20 mA, 4-20 mA. Resolution: display x 1 μ A, Accuracy $\pm 1,6$ μ A

Power sourcing (for unit under test): 24 VDC min. 20 mA, max. 50 mA, tolerance $\pm 1V$

Operating conditions: 0°C...50°C, max. 80% relative humidity, non-condensing

(during battery charging: 0...45°C)

Storage conditions: -20°C...+60°C, max. 80% relative humidity, non-condensing

Graphic display: 128 x 128 pixel, 44.7 x 44.7 mm

Memory capacity: 16 calibration procedures with each 32 test points

RS232-parameters: 4800, 9600 or 11200 Baud, adjustable. (8 data bits, 1 stop bit, no parity)

Battery: Lithium-Ion rechargeable, with intelligent charging electronic

Battery charger: 230 VAC 50/60 Hz. (other on request)

Electrical sockets:

Charging socket 9V, 450 mA, ± 50 mA, with metal protection cap

Communication: USB and RS232, with metal protection cap

4 mm sockets for current measurement 4...20 mA

4 mm sockets for voltage measurement 0...1/5/10 V

4 mm sockets for pressure switch test

4 mm sockets for power sourcing of units under test 24V / 50 mA

Dimensions: appr. 12.5 x 21 x 8 cm (width x height x depth), Weight: appr. 1.1 kg

Pressure connection port of the LPC-S reference sensors: 1/2" BSP male acc. to EN 837

Available standard pressure ranges for LPC 300 reference sensors LPC-S:

Range [bar]	Overload protection [bar]	Burst pressure [bar]	
0...0.25	1.6	2.4	
0...0.4	2	2.4	also as ABSOLUTE
0...0.6	4	4.8	also as ABSOLUTE
0...1	5	6	also as ABSOLUTE
0...1.6	10	12	also as ABSOLUTE
0...2.5	10	12	also as ABSOLUTE
0...4	17	20.5	also as ABSOLUTE
0...6	35	42	also as ABSOLUTE
0...10	35	42	also as ABSOLUTE
0...16	80	96	also as ABSOLUTE
0...25	50	96	
0...40	80	400	
0...60	120	550	
0...100	200	800	
0...160	320	1000	
0...250	500	1200	
0...400	800	1500	
0...600	1200	1500	
0...1000	1500	3000	
-0.4...0	2	2,4	
-0.6...0	4	4,8	
-1...0	5	6	
-0.25...+0.25	1.6	2.4	
-0.4...+0.4	2	2.4	
-0.6...+0.6	4	4.8	
-1...+1.5	10	12	
-1...+3	17	20.5	
-1...+5	35	42	
-1...+9	35	42	
-1...+15	80	96	
-1...+24	50	96	
-1...+39	80	400	

*) calibrated at +23°C, incl. linearity, hysteresis and repeatability.

NOTE:

Conversion into other pressure units:

If you want to select another pressure unit, the LPC 300 checks, if the full scale value in the wanted pressure unit is ≤ 9999.99 . If yes, the requested pressure unit can be selected. If no, the requested pressure unit cannot be selected.

Used conversion factors:

1.00000E+00	bar
1.00000E-03	mbar
1.00000E-03	hPa
6.89476E-02	psi
3.38638E-02	inHg (at 0°C)
1.33322E-02	cmHg (at 0°C)
1.00000E+01	MPa
1.00000E-02	kPa
1.00000E-05	Pa
9.80670E-02	mH2O (at 4°C)
9.80638E-04	cmH2O (at 4°C)
9.80670E-05	mmH2O (at 4°C)
9.80665E-01	kg/cm ² = kp/cm ²
2.48840E-03	inH2O (at 60°F)
1.33322E-03	mmHg (at 0°C)



DRUCK & TEMPERATUR Leitenberger GmbH

Bahnhofstr. 33 • D-72138 Kirchentellinsfurt • Germany • www.Leitenberger.com
Tel. +49-7121-90920-0 • Fax +49-7121-90920-99 • E-Mail: DT-Export@Leitenberger.de



11.1 Optional Accessories

Type	Description	Order-Code
LPC-Cal	PC-Windows-Software with RS232-cable (see information on page 28)	LPC300-SW-RS232
	ditto, but with USB-cable	LPC300-SW-USB
	ditto, but with both cables	LPC300-SW-RS-USB
LPC-Kabel	Extension cable for LPC-S reference sensor, 1.1 m	LPC-KABEL
LPC-Koffer	Carrying case with foams for LPC 300	LPC300-KOFFER
LPP 30	Calibration Handpump, pneumatic generating pressure up to 35 bar, switchable to generating vacuum up to -0.95 bar. Test port via hose, 1/4" BSP female	LPP-30
LPP-Koffer	Carrying case with foams for LPP 30	LPP-KOFFER
LSP 1000-LC	Pressure comparator (spindle pump) Operating fluid: oil or distilled water generating pressure up to 1000 bar	LSP-1000-LC
LSP 1000-K	portable version in aluminium case	LSP-1000-K
LSP 1200-DL	ditto, but generating pressure up to 1200 bar	LSP-1200-DL
LSP 1600-DL	ditto, but generating pressure up to 1600 bar	LSP-1600-DL



LPP 30



LSP 1000-LC



12. Windows®-Software *LPC-Cal*

System Requirements:

Windows®-PC (Win 98SE, 2000/SP4, XP), Keyboard, Mouse, SVGA color monitor, Printer, COM- or USB-port, Microsoft®-Excel® Vers. 97, 2000, 2002 (XP) or 2003, LPC 300-connection cable RS232 or USB.

Instructions for USB-connection:

If you wish to connect your LPC 300 to your PC/Notebook using the USB port, and you have the connection cable and the LPC-Cal software, please first follow this instructions in order to install the USB-driver:

- (a) On the LPC-Cal software CD-ROM, you can find a folder named *USB-Treiber LPC 300*. In this folder there is the file *usb-treiber_lpc300.exe*.
- (b) **Before** connecting the LPC 300 to the USB port of your PC/Laptop, run the program file *usb-treiber_lpc300.exe* (double click on the file name in Windows®-Explorer. This will create a new folder on your hard drive (recommended path: *C:\SiLabs*).
- (c) Now connect the LPC 300 to an USB-port of your PC/Laptop. The "automatic hardware recognition" within the Windows® operating system will launch automatically.
- (d) Now select the option that you have your own driver and refer to the driver folder (usually *C:\SiLabs\MCU\CP210x\WIN*). The system will then create a **virtual** COM port. You then need to select this COM-port number as "your" COM port withing the LPC-Cal software.

NOTES:

To install the USB drivers you will need an user account with administrator rights. If you do not have this, please contact your system administrator.

If you are not sure which is the virtual COM port number that has been created, please check the correct COM port number of the newly-created virtual COM port for the LPC 300 via the Windows® Control Panel in Device Manager (under "Ports - COM and LPT").

LPC-Cal: Install and Use:

To install the LPC-Cal Software, run the program *setup.exe* from the LPC-Cal CD-ROM. If possibly, try to use the recommended installation folders. After installation, a new program group **LPC-Cal** will appear in the Start Menu of your Windows® operating system.

When you run LPC-Cal for the first time, you will be asked to select the required language (e.g. ENGLISH), as well as the version of Microsoft®-Excel® that you are running (which LPC-Cal will use for creating a printable certificate). In addition you can specify the folder in which future calibration certificates, generated via LPC-Cal and Excel® will be saved. Next, select the correct COM port by clicking on the serial connector icon (top left of the LPC-Cal main screen).

Next, please click on the button "read data" on the bottom left corner of the LPC-Cal main screen to download the calibration data from your LPC 300 to your PC/Notebook.

Next, select the desired calibration data by clicking on the Check Boxes and then click on the button "create Certificates". An Excel worksheet is then generated, which you can customise (the master workbook is named "calmaster.xls").

NOTE: If the message "ActiveX Object Creation not possible" appears after clicking the "create Certificates" button, this indicates that the (during Install of LPC-Cal) selected version of Excel® is not installed on your PC/Laptop. In this case, please contact your System Administrator.

NOTE:

LPC-Cal requires an installed Microsoft® Excel® version 2000, XP or 2003 on your PC/Laptop.



DRUCK & TEMPERATUR Leitenberger GmbH

Bahnhofstr. 33 • D-72138 Kirchentellinsfurt • Germany • www.Leitenberger.com
Tel. +49-7121-90920-0 • Fax +49-7121-90920-99 • E-Mail: DT-Export@Leitenberger.de



Wählen Sie am PC die zu übertragenden Kalibrierdaten (Prüflinge) aus und erstellen Sie mit Microsoft Excel ein Kalibrierzertifikat.

Tragen Sie hier Ihren eigenen Firmennamen ein

Fügen Sie hier Ihr eigenes Firmen-Logo ein

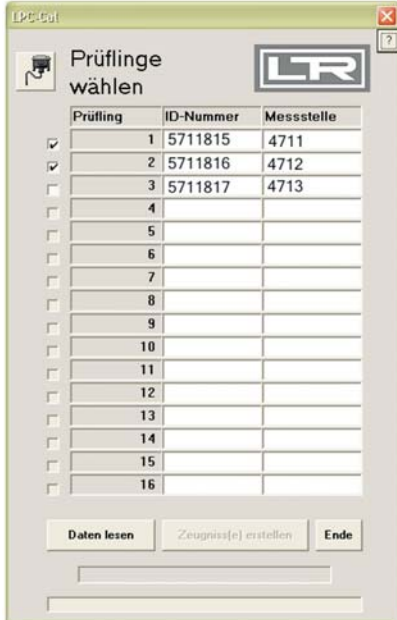

DRUCK & TEMPERATUR Leitenberger GmbH



Abnahmeprüfzeugnis 3.1 nach DIN EN 10204
Acceptance Test Certificate 3.1 according to EN 10204

Kunde: Karl Mustermann GmbH
Customer: Musterweg 28
12345 Musterhausen

Zeugnis-Nr. **61**
Certificate No.
Datum: 15.07.2005
Date:

Kundenbestell-Nr.: 0815-4711
Custom Order No.:
Bestelldatum: 01.07.2005
Order date:
Auftrag / Position: 1
Order No. / Item:

Typ: TDMC
Type:
Genauigkeit: ±0,2% v.E.
Accuracy

Messbereich: 0 ... 20 bar
Range:
Ausgangssignal: -/
Output signal

Serien-Nr.: 8155416
Serial No.:
Messstellen-Nr.: 4712
Tag No.

Referenzgerät: LPC 300 (373A)
Reference instrument:
0...25 bar
0,025 %

Ergebnis: Kalibriertemp. 25°C
Results: Temperature

Referenz reference bar	Prüfling test item bar	Fehler deviation bar	Fehler deviation %
0,00000	0,00000	0,00000	0,00000
2,00100	2,00000	-0,00100	0,00000
4,03002	4,00000	-0,03002	-0,00003
6,04003	6,00000	-0,04003	-0,00004
8,01220	8,00000	-0,01220	-0,00001
10,01045	10,00000	-0,01045	-0,00001
12,00989	12,00000	-0,00989	-0,00001
13,99870	14,00000	0,00130	0,00000
15,98012	16,00000	0,01988	0,00002
17,99147	18,00000	0,00853	0,00001
19,98775	20,00000	0,01225	0,00001
18,01006	18,00000	-0,01006	-0,00001
16,02558	16,00000	-0,02558	-0,00003
14,00998	14,00000	-0,00998	-0,00001
12,01000	12,00000	-0,01000	-0,00001
9,99975	10,00000	0,00025	0,00000
8,00145	8,00000	-0,00145	0,00000
6,00457	6,00000	-0,00457	0,00000
4,01006	4,00000	-0,01006	-0,00001
1,99875	2,00000	0,00126	0,00000
-0,00548	0,00000	0,00548	0,00001

Das Layout können Sie selbst nach Ihren Wünschen verändern.

System-Voraussetzungen:

- Windows-PC
- Win 98SE, 2000 (SP4), XP
- Tastatur & Maus
- SVGA-Farbbildschirm
- Drucker
- COM-Port oder USB-Anschl.
- Installiertes Microsoft Excel Vers. 97, 2000, XP oder 2003

Außerdem benötigen Sie folgendes LPC 300-Zubehör:

- RS232-Kabel für LPC 300 mit Software LPC-Cal
Art.-Nr. LPC300-SW-RS232 oder
- USB-Kabel für LPC 300 mit Software LPC-Cal
Art.-Nr. LPC300-SW-USB oder
- Beide Kabel für LPC 300 mit Software LPC-Cal
Art.-Nr. LPC300-SW-RS-USB

Der Kalibriergegenstand hält die Fehlergrenzen nach Herstellerangaben ein: ja / yes nein / no
Object keeps the specification:

Die Kalibrierung erfolgte auf der Grundlage der folgenden Norm
Calibration was carried out according to the following norm
• EN 837-1
• EN 837-3

Firmensachverständiger: Knut Kalibrix
Company Expert:

Zertifikat erstellt mit elektronischem Druckkalibrator LPC 300 und Kalibrier-Software LPC-Cal (www.druck-temperatur.de)
Certificate created with electronic pressure calibrator LPC 300 and calibration software LPC-Cal (www.druck-temperatur.de)



DRUCK & TEMPERATUR Leitenberger GmbH
Bahnhofstr. 33 • D-72138 Kirchentellinsfurt • Germany • www.Leitenberger.com
Tel. +49-7121-90920-0 • Fax +49-7121-90920-99 • E-Mail: DT-Export@Leitenberger.de

