

The diaphragm seal is designed to measure the process fluid pressure when the process fluid temperature is non-compatible to the instrument sensing element; when the process fluid may corrode the inner parts of the measuring instrument in contact with the fluid; when the fluid is highly viscous or it contains solid suspensions; when it solidifies at temperature changes. It is also used for long-distance pressure fluid transmission and measurement allowing to isolate dangerous fluids from the operating areas. It can be directly connected to the indicating instrument or through a capillary.

OPERATING PRINCIPLE

The diaphragm seal operating principle is based on the fluids non-compressibility (see drawing at right).

The separation from the process fluid is obtained from an elastic diaphragm sealed to the diaphragm seal body. The inner chamber between the diaphragm and the Bourdon tube is at first evacuated than filled with properly degassed fill-fluid. At this point the system is able to transmit the mechanical stress produced by the process fluid on the diaphragm to the Bourdon tube.

Any air bubble in the circuit must be avoided as it could affect the right system operation.

RECOMMENDATIONS

The diaphragm and the body are in contact with the process fluid, therefore they must withstand the temperature and the possible fluid chemical aggression. A guide to the choice of the materials to use depending on the process medium is available under section "CORROSION/MATERIALS".

The filling fluid must be selected depending on the pressure fluid nature and temperature as well since any diaphragm fail may contaminate the process fluid and damage the whole process plant. A guide for a filling-fluid selection is available under section "FILLING FLUID".

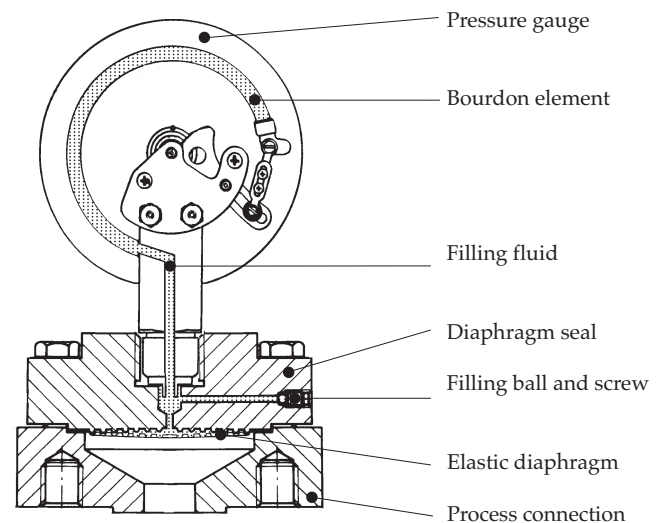

FUNCTIONAL CHARACTERISTICS

Accuracy: at 20°C $\pm 0,5...1\%$, depending on the diaphragm seal type. This accuracy value must be added to the pressure gauge accuracy.

Process fluid temperature: minimum -45°C, maximum 340°C, depending on the filling fluid, on the diaphragm material and on the process connection. For temperature higher than the indicated limits please contact the Technical Service Department.

TEMPERATURE INFLUENCE

The complete seal system composed by the diaphragm seal (with or without capillary) and the measuring instrument, is filled with a fixed amount of liquid at a fixed room temperature (generally $+20^{\circ}\text{C} \pm 2^{\circ}\text{C}$), called temperature of reference. Any ambient or fluid process temperature change produces a proportional variation of the filling fluid volume causing an inner pressure change that makes a zero off at the indicating instrument. In order to minimize such an error it is necessary to compensate the volume modified by temperature variations.

Diaphragm of small diameter can compensate only little volume changes (see Fig.1). It is recommended to use, in line with process requirements, diaphragm seals with large size diameter. In order to prevent the effects of temperature conduction between the diaphragm seal and the instrument, when the process temperature exceeds 100°C , it is required to fit the instrument with:

- Cooling element
- Capillary mounting

COOLING TOWER

The purpose of the cooling element is to protect the instrument from high temperatures. It reduces the filling fluid temperature inside the instrument to approximately the room temperature. The cooling element is recommended for instruments direct mounting when the process temperature is exceeding $+100^{\circ}\text{C}$ but is not higher than $+250^{\circ}\text{C}$.

When a diaphragm seal provided with cooling element is installed on an insulated pipe, it is fundamental that the insulating coat is not covering the element radiant surface in order to assure the system proper working.

REMOTE MOUNTING (with capillary)

The capillary allows the instrument reading when it is far from the process connection. The capillary avoids the fluid process temperature effect on the instrument accuracy.

A 500mm capillary is generally long enough to reduce the indicating instrument temperature to the ambient temperature.

The capillary length must be as short as possible and it should not exceed 6mt because any ambient temperature variation could affect the instrument accuracy and response time (see fig.2).

The remote mounting requires instruments for wall or panel mounting. If the level difference is known, it must be indicated in order. If not a field adjustment of the micromatic pointer in order to compensate the effect of extreme temperature variation, will be necessary.

Tab. 1 - FILLING LIQUIDS

Liquid type	Limits of process temperature
Silicone oil type "A"	-45 ... +150 °C
Silicone oil type "B"	-20 ... +250 °C
Silicone oil type "C"	+20 ... +340 °C
"Fluorolube"	-60 ... +150 °C
Food oil	-20 ... + 200 °C

Glycerine or silicone should not be used with highly oxidizing agents such as oxygen, chlorine, nitric acid or hydrogen peroxide, because of spontaneous chemical reaction, inflammability or explosion. The use of fluorinates fluid is recommended in these cases.

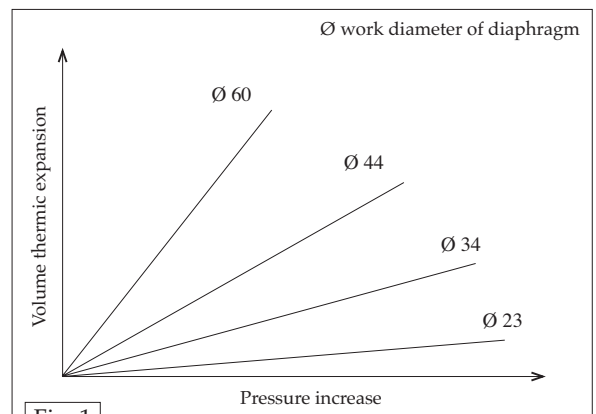

Fig. 1

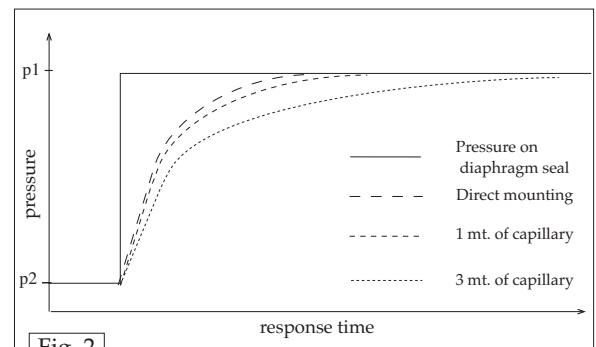

Fig. 2

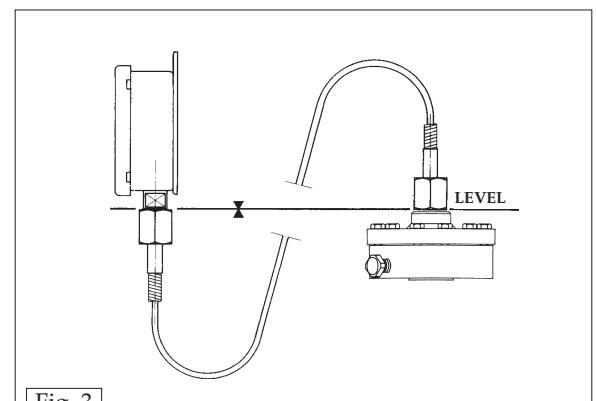

Fig. 3

Tab.2 - DIAPHRAGM SEAL CHOICE

An improper use of the instrument may be dangerous to the diaphragm seal, may cause failure and potential injury to the staff and plant.

Caution: all diaphragm seals must be chosen considering the process fluid and the working conditions in order to prevent inaccurate installations.

For material choice please see recommendations quoted on sheet 5...8.

For process fluids not listed in our guide (the material's life depends on temperature and process fluid concentration as well as for other working conditions) please contact our Technical Department.

In case of uncomplete knowledge of the process fluid behaviour, it is suggested to install the diaphragm seal with a solid front pressure gauge.

In case of tube failure this instrument prevents that dangerous process fluid may hit the workers.

Type	∅ diaphragm	Facing diaphragm	Welded diaphragm	Thread connection	Flanged connection
1B0	73,5			◆	
1A0	44			◆	
1AS	44			◆	
111	38		◆	◆	
6W0-F	63		◆	◆	◆
MIA	34		◆	◆	
MIB	57		◆	◆	
MIM	44		◆	◆	
SAN	23,5 ... 44	◆	◆	◆	
ALI	34 ... 63	◆	◆		◆
R00	38	◆	◆		◆
367	23,5	◆	◆	◆	
3A0	44				◆
3B0	73,5				◆
600	73,5				◆
500	38...63	◆	◆		◆
400	34...57	◆	[1]		◆

[1] Please contact our Technical Department

DIAPHRAGM SEAL INSTALLATION

The whole system (the pressure gauges with their diaphragm seal) must be kept packaged until installation time in order to protect all the components. Particular care must be taken to prevent damages to the diaphragm during installation of the system on the process. Scratches on the diaphragm surface are the starting point for chemical corrosion action while crush of concentric waves of the diaphragm surface may compromise the system operation.

The capillary and its welded joints to the body must not be bended or twisted. Capillary must not be used as handle for transportation of the system. Bends or extreme bending radius of capillary may cause throttling of the inner hole, may increase the response time or cause capillary breaking compromising the regular instrument operation. The capillary may bend with a minimum of 150mm. bending radius.

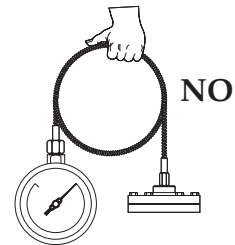

Extreme care must be taken to the sealing gasket mounting between diaphragm seal and process side to cover the diaphragm preventing damages or process fluid leakage.

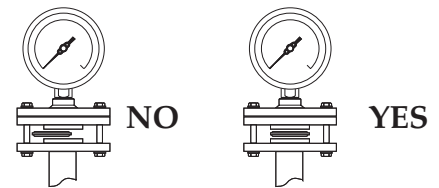

On models with threaded process connection, the mounting must be made through the key flat of the diaphragm seal body and not through the pressure range key flat: this may cause disassemble of the gauge/diaphragm system with eventually leakage of filling fluid.

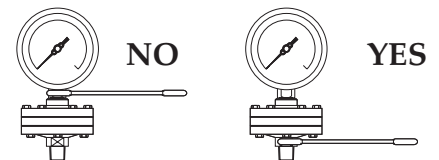

DIAPHRAGM SEAL FASTENING

All diaphragm seals are coupled and fastened to the instruments (except 63mm.) through a label seal. The tampering of the label seal or of the diaphragm seal/instrument coupling compromises their operation and warranty.

DO NOT REMOVE

DIAPHRAGM MATERIAL <input type="checkbox"/> AISI 316 L <input type="checkbox"/> HASTELLOY B <input type="checkbox"/> HASTELLOY C	<input type="checkbox"/> MONEL <input type="checkbox"/> PTFE <input type="checkbox"/> TANTALUM	FILLING A B C <input type="checkbox"/> SILICON OIL <input type="checkbox"/> FOOD OIL <input type="checkbox"/> FLUOROLUBE
---	--	---

USE OF THE DIAPHRAGM SEAL

The working temperature must not exceed the limit of the material in use.

Working pressure: the maximum working pressure must be $\leq 75\%$ of the range of the instrument coupled with the diaphragm seal. For flanged diaphragm seal the maximum working pressure must also be within the flange rating pressure. The maximum admitted pressure on the diaphragm seal decreases when the temperature increases. To this subject please see table 5 where the connection between pressure/temperature for flange made with different materials are listed.

Temperature: the working temperature must be that of the instrument calibration and must be compatible with the chosen materials. For temperature exceeding 100°C diaphragm seals with capillary or with cooling system are recommended.

Oxygen and other oxidizing agents: glycerine and silicone should not be used with highly oxidizing agents such as oxygen, chlorine, nitric acid or hydrogen peroxide because of danger of spontaneous chemical reactions, inflammability or explosion. In these cases the use of fluorinates is recommended.(see tab.1)

MAINTENANCE

Periodically it may be necessary to remove sediments from the diaphragm and to check the corrosion or wear conditions of the entire system. This operation must be carried out by specially trained staff. The diaphragm seal and its pressure gauge must be removed from process and inspected than the diaphragm must be cleaned without using any tool that could damage it but with a solvent properly chosen according to the sediment to be removed.

Tab.3 - Material available C=Connection M=Diaphragm seal

Type	C.st.	AISI 316 st.st.	C.st. + PTFE	AISI 316 st.st. + PTFE	AISI 316 L st.st.	Monel 400	Hast. C276	Hast. B2	Titanium	Nickel	Tantalium	Incolloy 825	Inconel 600
1B0	C	C	C	CM	CM	CM	CM	CM	CM	CM	CM		
1A0		C			CM	CM	CM	CM					
1AS		C			CM	M	M						
111		C			M		M						
6W0-F		C			CM	CM	CM	CM			M		
MIA		C			M								
MIB		C			M								
MIM		C			M								
SAN		C			M								
ALI		C			M								
R00		C			M								
367		C			M								
3A0	C	C			M	CM	CM	CM			M		
3B0	C	C	C	CM	M	CM	CM	CM	M	M	M		
600	C	C	C	CM	CM	CM	CM	CM	M	M	M		
500		C			CM		CM	CM					
400		C		C	CM	CM	CM	CM	CM	CM	CM	M	M

Tab.4 - Ranges available

Type (1)	-1...0	0...1	0...1,6	0...2,5	0...4	0...6	0...10	0...16	0...25	0...40	0...60	0...100	0...160	0...250	0...400	0...600
1B0	♦	♦	♦	♦	♦	♦	♦	♦	♦	♦						
1A0											♦	♦	♦	♦	♦	
1AS															♦	♦
111						♦	♦	♦	♦	♦	♦	♦	♦	♦		
6W0-F	♦	♦	♦	♦	♦	♦	♦	♦	♦	♦	♦	♦	♦			
MIA													♦	♦	♦	♦
MIB		♦	♦	♦	♦	♦	♦	♦	♦	♦	♦					
MIM						♦	♦	♦	♦	♦	♦					
SAN 1" - DN25							♦	♦	♦	♦						
SAN 1" 1/2 - DN40					♦	♦	♦	♦	♦	♦						
SAN 2" - DN50				♦	♦	♦	♦	♦	♦	♦						
ALI 1" 1/2						♦	♦	♦								
ALI 2"					♦	♦	♦	♦								
ALI 2" 1/2				♦	♦	♦	♦	♦								
R00							♦	♦	♦	♦	♦	♦	♦	♦		
367										♦	♦	♦	♦	♦	♦	
3A0											♦	♦	♦	♦		
3B0	♦	♦	♦	♦	♦	♦	♦	♦	♦	♦						
600	♦	♦	♦	♦	♦	♦	♦	♦	♦	♦						
500			♦	♦	♦	♦	♦	♦	♦	♦	♦	♦	♦	♦		
400		♦	♦	♦	♦	♦	♦	♦	♦	♦						

(1) Ranges are indicated in bar and they are related to the DS of the instrument installed as well as the flange rating. For further information see the concerning catalogue sheet.

PRESSURE/TEMPERATURE RATING
(in according to standard ANSI/ASME B16.5 - ISO 7005)

Tab. 5 - Class 150 (PN 290 psi - PN 20 bar)

Temperature		Pressure (psi)						
°F	°C	C.st.	AISI 304	AISI 316	AISI 316L	Monel	Hast. B	Hast. C
-20+100	-29+38	285	275	275	230	230	290	290
200	93	260	230	235	195	200	260	260
300	149	230	205	215	175	190	230	230
400	204	200	190	195	160	185	200	200
500	260	170	170	170	145	170	170	170
600	316	140	140	140	140	140	140	140
650	343	125	125	125	125	125	125	125
700	371	110	110	110	110	110	110	110
750	399	95	95	95	95	95	95	95
800	427	80	80	80	80	80	80	80

Tab. 6 - Class 300 (PN 750 psi - PN 50 bar)

Temperature		Pressure (psi)						
°F	°C	C.st.	AISI 304	AISI 316	AISI 316L	Monel	Hast. B	Hast. C
-20+100	-29+38	740	720	720	600	600	750	750
200	93	675	600	620	505	530	750	750
300	149	655	540	560	455	495	730	730
400	204	635	495	515	415	480	705	705
500	260	600	465	480	380	475	665	665
600	316	550	435	450	360	475	605	605
650	343	535	430	445	350	475	590	590
700	371	535	425	430	345	475	570	570
750	399	505	415	425	335	470	530	530
800	427	410	405	420	330	460	510	510

Tab. 7 - Class 600 (PN 1500 psi - PN 110 bar)

Temperature		Pressure (psi)						
°F	°C	C.st.	AISI 304	AISI 316	AISI 316L	Monel	Hast. B	Hast. C
-20+100	-29+38	1480	1440	1440	1200	1200	1500	1500
200	93	1350	1200	1240	1015	1055	1500	1500
300	149	1315	1080	1120	910	990	1455	1455
400	204	1270	995	1025	825	955	1410	1410
500	260	1200	930	955	765	950	1330	1330
600	316	1095	875	900	720	950	1210	1210
650	343	1075	860	890	700	950	1175	1175
700	371	1065	850	870	685	950	1135	1135
750	399	1010	830	855	670	935	1065	1065
800	427	825	805	845	660	915	1015	1015

Tab. 8 - Class 900 (PN 2250 psi - PN 150 bar)

Temperature		Pressure (psi)						
°F	°C	C.st.	AISI 304	AISI 316	AISI 316L	Monel	Hast. B	Hast. C
-20+100	-29+38	2220	2160	2160	1800	1800	2250	2250
200	93	2025	1800	1860	1520	1585	2250	2250
300	149	1970	1620	1680	1360	1485	2185	2185
400	204	1900	1490	1540	1240	1435	2115	2115
500	260	1795	1395	1435	1145	1435	1995	1995
600	316	1640	1310	1355	1080	1435	1815	1815
650	343	1610	1290	1330	1050	1435	1765	1765
700	371	1600	1275	1305	1030	1435	1705	1705
750	399	1510	1245	1280	1010	1405	1595	1595
800	427	1235	1210	1265	985	1375	1520	1520

Tab. 9 - Class 1500 (PN 3750 psi - PN 260 bar)

Temperature		Pressure (psi)						
°F	°C	C.st.	AISI 304	AISI 316	AISI 316L	Monel	Hast. B	Hast. C
-20+100	-29+38	3705	3600	3600	3000	3000	3750	3750
200	93	3375	3000	3095	2530	2640	3750	3750
300	149	3280	2700	2795	2270	2470	3640	3640
400	204	3170	2485	2570	2065	2390	3530	3530
500	260	2995	2330	2390	1910	2375	3325	3325
600	316	2735	2185	2255	1800	2375	3025	3025
650	343	2685	2150	2220	1750	2375	2940	2940
700	371	2665	2125	2170	1715	2375	2840	2840
750	399	2520	2075	2135	1680	2340	2660	2660
800	427	2060	2015	2110	1645	2290	2540	2540

Tab. 10 - Class 2500 (PN 6250 psi - PN 420 bar)

Temperature		Pressure (psi)						
°F	°C	C.st.	AISI 304	AISI 316	AISI 316L	Monel	Hast. B	Hast. C
-20+100	-29+38	6170	6000	6000	5000	5000	6250	6250
200	93	5625	5000	5160	4220	4400	6250	6250
300	149	5470	4500	4660	3780	4120	6070	6070
400	204	5280	4140	4280	3440	3980	5880	5880
500	260	4990	3880	3980	3180	3960	5540	5540
600	316	4560	3640	3760	3000	3960	5040	5040
650	343	4475	3580	3700	2920	3960	4905	4905
700	371	4440	3540	3620	2860	3960	4730	4730
750	399	4200	3460	3560	2800	3900	4430	4430
800	427	3430	3360	3520	2740	3820	4230	4230

Tab. 11 - CORROSION vs. MATERIAL

Corrosive Substance	Temp. °F	Temp. °C	Concentration	C.Steel	AISI 304 st.st.	AISI 316 st.st.	Bronze	Brass	Monel 400	Nickel	Hastelloy B	Hastelloy C	Tantalum	PVC	Halar	Teflon	VITON	Fluorotube
Acetic Acid	200	93,3	All	D	C	B	C	D	C	D	C	A	A	C	A	A	C	
Acetic Anhydride	175	79,4	All	D	D	B	D	D	C	C	B	A	A	D	A	A	C	
Acetone	100	37,8	All	B	B	B	A	A	A	A	A	A	A	D	A	A	C	
Acetylene, Dry	400	204,4	100	A	A	A	D	D	B	B	A	A	A	A	A	A	A	
Alcohols	212	100	All	B	B	A	A	A	A	A	A	A	A	A	A	A	A	
Alkali Cleaners	212	100	All	C	B	A	B	D	A	A	A	B	B	A	A	A	A	
Aluminium Chloride	212	100	All	D	D	D	D	D	D	D	A	B	A	A	A	A	A	
Aluminium Hydroxide	212	100	All	B	B	B	B	B	B	B	C	B	A	A	A	A	B	
Aluminium Sulphate	212	100	All	D	D	A	C	D	D	D	A	A	A	A	A	A	A	
Amil Acetate	250	121,1	All	B	B	A	A	A	A	A	A	A	A	D	C	A	C	
Ammonium Chloride	212	100	<40	D	D	C	C	D	B	B	B	A	A	A	A	A	A	
Ammonium, Dry	600	315,6	100	A	A	A	D	D	A	A	A	A	C	A	A	A	C	
Ammonium Hydroxide	212	100	All	B	B	B	D	D	D	D	B	D	A	A	A	A	B	
Ammonium Nitrate	212	100	All	D	C	B	D	D	D	D	C	B	A	A	A	A	C	
Ammonium Sulphate	212	100	<50	D	D	B	C	D	B	B	C	B	A	A	A	A	C	
Aniline	250	121,1	100	A	A	A	D	D	B	B	B	B	A	D	C	A	C	
Argon	300	148,9	100	A	A	A	A	A	A	A	A	A	A	A	A	A	A	
Asphalt	250	121,1		B	B	A	B	B	A	A	B	A	A	B	A	A	A	
Atmosphere, Ind. & Marine				B	A	A	A	B	A	A	A	A	A	A	A	A	A	
Atmosphere, Rural				B	A	A	A	A	A	A	A	A	A	A	A	A	A	
Bauxite & Water	212	100	All	B	B	A	B	B	B	B	B	B	A	A	A	A	A	
Benzene	212	100	All	B	B	B	A	B	A	A	B	B	A	C	C	A	B	
Benzidine				B	B	B	B	B	B	B	B	B	A	C	A	A	B	
Benzoic Acid				D	D	B	C	C	B	B	A	A	A	A	A	A	A	
Bier	70	21,1		C	C	A	A	B	A	A	A	A	A	A	A	A	A	
Borax (sodium borate)	212	100	<50	B	B	C	A	A	A	A	A	B	A	A	A	A	A	
Boric Acid	212	100	All	D	D	B	B	B	B	B	A	A	A	A	A	A	A	
Bromine, Dry	125	51,7	100	D	D	D	D	D	A	A	A	A	A	D	A	A	A	
Bromobenzene	212	100	100	C	B	B	B	B	B	B	B	B	A	C	B	A	B	
Butane	212	100		A	A	A	A	A	A	A	A	A	A	B	A	A	A	
Butyl Alcohol	212	100		B	A	A	A	A	A	A	A	A	A	A	A	A	A	
Butyric Acid	212	100	All	D	C	B	C	D	B	C	B	A	A	C	A	A	C	
Calcium Bisulphite	212	100	All	D	C	B	D	D	D	D	D	C	A	A	A	A	A	
Calcium Chloride	212	100	All	C	C	C	B	C	B	A	B	A	A	A	A	A	A	
Calcium Hydroxide	212	100	10	B	B	B	B	B	B	B	B	A	C	A	A	A	A	
Calcium Hypochlorite	212	100	All	D	D	D	C	C	D	D	C	B	A	A	A	A	B	
Carbon Dioxide, Dry	100	37,8		A	A	A	A	A	A	A	A	A	A	A	A	A	A	
Carbon Sulphide	125	51,7		B	B	A	B	A	B	B	A	A	A	D	A	A	A	
Carbon Tetrachloride, Dry	212	100	100	C	A	A	A	C	A	A	D	B	A	D	C	A	A	
Carbon Tetrachloride, Moist	212	100		D	D	C	D	D	A	A	D	B	A	D	C	A	A	
Carbonated Water	212	100	All	D	A	B	B	D	C	C	A	A	A	A	A	A	A	
Carbonic Oxide	300	148,9		A	A	A	A	B	A	A	A	A	A	A	A	A	A	
Caustic Potassium	212	100	<50	D	B	B	D	D	A	A	B	C	D	A	A	A	C	
Caustic Soda	212	100	All	C	C	C	D	D	B	B	B	C	D	A	A	A	C	
Caustic Soda	212	100	<40	C	B	A	B	D	A	A	A	B	D	A	A	A	C	
Cement Slurry	212	100	All	B	A	A	B	B	B	B	B	B	C	A	A	A	C	
Chloride	500	260		B	A	A	D	D	B	C	B	A	A	A	A	A	C	
Chlorine Dioxide	150	65,6		D	D	D	D	D	D	D	B	B	A	D	B	A	B	
Chlorine, Dry	200	93,3	100	B	B	C	B	C	B	B	C	A	A	C	A	A	A	
Chlorine, Moist	200	93,3	All	D	D	D	D	D	D	D	D	A	A	C	A	A	A	
Chloroacetic Acid	212	100	All	D	D	D	D	D	C	C	B	A	A	C	A	A	C	
Chlorobenzene	150	65,6	100	C	B	B	B	C	B	B	B	B	A	D	B	A	A	
Chloroform, Dry	150	65,6	100	A	B	C	B	B	A	A	B	B	A	C	B	A	A	
Chromic Acid	212	100	All	C	D	D	D	D	D	D	D	D	A	C	A	A	A	
Chromium Plating Solution	212	100	All	C	D	D	D	D	D	D	D	D	A	C	A	A	A	
Citric Acid	212	100	All	D	C	A	C	D	C	C	A	A	A	A	A	A	A	
Coffee	212	100	All	D	B	A	A	C	B	B	B	A	A	A	A	A	A	
Copper Chloride	212	100	All	D	D	D	C	D	D	D	D	D	A	A	A	A	A	
Copper Nitrate	212	100	All	D	B	B	D	D	D	D	D	D	A	A	A	A	A	
Copper Plating Solutions (Acid)	212	100	All	D	C	B	D	D	B	B	C	C	A	A	A	A	A	

A = Recommended Best service life Attack < 0,05 mm/year
 B = Suitable Good service life Attack 0,05...0,5 mm/year
 C = Not recommended Fair service life Attack 0,5...1,27 mm/year
 D = Unsuitable No service life Attack > 1,27 mm/year

This tab is a guide. The purchaser will directly choose the most suitable material for the process conditions. (The diaphragm thickness goes from 0,05 mm to 0,15mm according to the material and the diaphragm type chosen.) For further information please contact our Service Technical Department.

Tab. 11 - CORROSION/MATERIAL

Corrosive substance	Temp. °F	Temp. °C	Concentration	C.Steel	AISI 304 st.st.	AISI 316 st.st.	Bronze	Brass	Monel 400	Nickel	Hastelloy B	Hastelloy C	Tantalum	PVC	Halar	Teflon	VITON	Fluorolube
Copper Plating Solutions (cyanide)	212	100	All	B	A	A	D	D	B	B	B	A	A	A	A	A	A	A
Copper Sulphate	212	100	<40	D	C	B	C	D	D	D	C	A	A	A	A	A	A	A
Corn Oil	500	260	All	D	B	A	A	C	B	B	A	A	A	A	A	A	A	A
Creosol	212	100	All	B	A	A	B	C	B	B	B	A	A	D	A	A	A	A
Creosote	212	100		B	B	B	B	C	B	B	B	A	A	D	A	A	A	A
Crude Oil	300	148.9	All	B	B	B	B	C	A	B	B	C	A	B	A	A	A	A
Ethanol	212	100	All	B	A	A	A	A	A	A	B	A	A	A	A	A	A	A
Ethyl Acetate	212	100	100	D	B	B	B	B	B	C	C	B	A	D	C	A	C	
Ethyl Chloride, Dry	212	100		B	C	A	A	A	B	A	B	B	A	D	A	A	A	
Ethylene Glycol	212	100	All	C	B	B	B	B	B	B	A	A	A	A	A	A	A	A
Ethylene Oxide	75	23.9	100	B	A	B	D	D	B	B	A	A	A	C	B	A	C	
Fatty Acids	500	260	100	D	C	A	C	C	B	A	A	A	A	A	A	A	A	A
Ferric Chloride	150	65.6	<50	D	D	D	D	D	D	D	D	B	A	A	A	A	A	A
Ferric Sulphate	150	65.6	10	D	B	A	D	D	D	B	B	A	A	A	A	A	A	A
Ferrous Chloride	212	100	<50	D	D	D	C	D	D	D	B	B	A	A	A	A	A	A
Ferrous Sulphate	212	100	All	D	C	B	C	D	C	D	B	B	A	A	A	A	A	A
Fluorine, Gas	300	148.9	100	D	A	A	C	C	A	A	C	B	D	B	A	A	C	
Fluorine, Liquid	75	23.9	100	D	A	A	B	C	A	A	C	B	C	B	B	A	C	
Fluorosilicic Acid	75	23.9	10	D	B	B	C	C	A	B	B	A	C	A	A	A	B	
Formaldehyde	212	100	<50	D	B	A	B	B	B	B	B	A	A	B	B	A	B	
Formic Acid	212	100	All	D	B	D	B	C	B	B	A	A	A	B	A	A	A	
Gasoline	200	93.3		A	A	A	A	A	C	A	A	A	A	B	A	A	A	
Glucose	300	148.9	All	B	A	A	A	A	A	A	A	A	A	A	A	A	A	
Glue	300	148.9	All	C	A	A	A	B	A	A	A	A	A	A	A	A	A	
Glycerine	212	100	All	B	A	A	B	B	A	A	A	A	A	A	A	A	A	
Hexane, Dry	212	100		A	A	A	A	A	A	A	A	A	A	A	A	A	A	
Hydrobromic Acid	212	100	All	D	D	D	D	D	D	D	B	D	A	B	A	A	A	
Hydrochloridric Acid	212	100	All	D	D	D	D	D	D	D	B	C	A	B	A	A	A	
Hydrofluoric Acid	212	100	All	D	D	D	C	D	B	D	B	B	D	C	A	A	C	
Hydrogen	500	260		B	A	A	A	A	A	A	A	A	A	A	A	A	A	
Hydrogen Chloride	400	204.4		D	C	C	D	D	A	A	A	A	A	A	A	A	A	
Hydrogen Fluoride, Dry	200	93.3	100	C	B	B	C	C	B	B	C	B	C	A	A	A	C	
Hydrogen Peroxide	212	100	30	D	C	B	D	D	C	C	C	C	A	A	A	A	A	
Hydrogen Peroxide	212	100	100	D	C	C	D	D	C	C	D	C	A	A	A	A	A	
Kerosene	300	148.9		A	A	A	A	A	A	A	A	A	A	A	A	A	A	
Lacquers & Thinners	200	93.3	All	B	A	A	A	B	A	A	A	A	A	D	C	A	C	
Lactic Acid	212	100	All	D	C	B	D	D	D	D	B	B	A	A	C	A	A	
Lime	212	100	All	B	B	B	B	B	B	B	B	A	A	A	A	A	A	
Linseed Oil	75	23.9		A	A	A	B	C	B	B	B	B	A	A	A	A	A	
Magnesium Chloride	212	100	<40	D	D	C	B	C	B	A	A	A	B	A	A	A	A	
Magnesium Oxide	212	100	All	B	B	B	A	B	B	A	B	B	D	A	A	A	A	
Magnesium Sulphate	212	100	<50	B	A	A	A	B	A	A	C	A	A	A	A	A	A	
Mercuric Chloride	75	23.9	10	D	D	D	D	D	D	C	C	B	A	A	A	A	A	
Mercury				A	A	A	D	D	C	B	B	B	A	A	A	A	A	
Methyl Chloride, Dry	212	100	100	A	B	A	A	B	B	B	B	B	A	D	A	A	A	
Methylene Chloride	212	100	100	C	C	C	C	B	B	C	A	A	A	D	C	A	B	
Milk				D	A	A	B	C	C	A	B	B	A	A	A	A	A	
Naphta	75	23.9	100	B	A	A	A	A	A	A	B	A	A	B	A	A	A	
Naphtaline	212	100	100	A	A	A	B	B	B	B	B	B	A	C	A	A	A	
Nickel Chloride	212	100	<40	D	D	C	D	D	B	C	A	B	A	A	A	A	A	
Nickel Sulphate	212	100		D	C	B	B	C	B	B	B	B	A	A	A	A	A	
Nitric Acid	75	23.9	All	D	A	A	D	D	D	D	D	B	A	A	A	A	A	
Nitric Acid	212	100	All	D	C	C	D	D	D	D	D	D	A	C	B	A	C	
Oxalic Acid	212	100	All	D	D	D	B	C	B	C	B	B	A	A	A	A	A	
Oxygen	300	148.9	All	A	A	A	A	A	A	A	A	A	A	A	A	A	A	
Perchloric Acid	120	48.9	All	D	D	D	D	D	D	D	C	D	A	D	A	A	A	
Phenol	175	79.4	100	B	B	A	A	B	A	A	A	A	A	C	A	A	A	
Phosphoric Acid	212	100	All	D	C	C	D	D	D	D	B	C	A	A	A	A	A	
Phthalic Anhydride	250	121.1	100	B	A	A	C	C	A	A	B	A	A	C	B	A	B	
Picric Acid	212	100	All	D	B	B	D	D	D	D	D	B	A	C	A	A	A	

A = Recommended Best service life Attack < 0,05 mm/year
 B = Suitable Good service life Attack 0,05...0,5 mm/year
 C = Not recommended Fair service life Attack 0,5...1,27 mm/year
 D = Unsuitable No service life Attack > 1,27 mm/year

This tab is a guide. The purchaser will directly choose the most suitable material for the process conditions. (The diaphragm thickness goes from 0,05 mm to 0,15mm according to the material and the diaphragm type chosen.) For further information please contact our Service Technical Department.

Tab. 11 - CORROSION/MATERIALS

Corrosive substances	Temp. °F	Temp. °C	Concentrations	Carbon steel	AISI 304 st.st.	AISI 316 st.st.	Bronze	Brass	Monel 400	Nickel	Hastelloy B	Hastelloy C	Tantalum	PVC	Halar	Teflon	VITON	Fluorotube
Propan	300	148,9		A	A	A	A	A	A	A	A	A	A	A	A	A	A	A
Quinine	212	100	100	D	B	B	B	B	B	B	B	B	A	A	A	A	A	A
Resin Solution	150	65,6	All	D	B	A	B	B	B	B	B	A	A	D	A	A	A	C
Rochelle Salt	212	100	100	D	B	B	B	C	B	B	B	B	A	A	A	A	A	A
Rosin	700	371,1	100	D	B	B	B	B	A	A	B	A	A	A	A	A	A	A
Sea Water	75	23,9		D	C	C	D	C	A	A	A	A	A	A	A	A	A	A
Silicate Solutions	212	100	All	B	A	A	B	B	A	A	A	A	A	A	A	A	A	A
Silicone Fluids	212	100	100	A	A	A	A	A	A	A	A	A	A	A	A	A	A	A
Silver Nitrate	212	100	<60	D	B	B	D	D	D	D	B	C	A	A	A	A	A	A
Soap & Detergents	212	100	All	B	A	A	A	B	A	A	A	A	A	A	A	A	A	A
Sodium Bicarbonate	212	100	20	B	A	A	B	B	A	A	B	B	A	A	A	A	A	A
Sodium Bisulphate	212	100	<10	D	B	B	B	D	B	B	B	B	A	A	A	A	A	A
Sodium Bisulphite	212	100	<40	D	D	C	C	C	B	C	C	B	A	A	A	A	A	A
Sodium Carbonate	212	100	<40	B	B	B	B	C	B	B	B	B	A	A	A	A	A	A
Sodium Chloride	212	100	<40	C	C	C	B	B	B	B	B	B	A	A	A	A	A	A
Sodium Cyanide	212	100	10	B	A	A	D	D	D	D	B	C	A	A	A	A	A	A
Sodium Hydroxide	180	82,2	<60	C	B	A	B	C	A	A	A	B	D	A	A	A	C	
Sodium Hypochlorite	75	23,9	10	D	D	D	D	D	D	D	C	A	A	A	A	A	A	A
Sodium Nitrate	212	100	<50	B	A	A	C	C	B	B	C	B	A	A	A	A	B	A
Sodium Nitrate	212	100	60	B	C	B	B	B	B	B	B	B	A	A	A	A	B	A
Sodium Peroxide	212	100	10	B	B	B	C	D	B	B	B	B	A	A	A	A	A	A
Sodium Phosphate (Tribasic)	212	100	All	B	A	A	B	B	B	B	A	B	A	A	A	A	A	A
Sodium Silicate	212	100	All	B	A	A	B	B	B	B	B	B	A	A	A	A	A	A
Sodium Sulphate	212	100	<50	B	B	B	B	B	B	B	B	B	A	A	A	A	A	A
Sodium Sulphate	212	100	10	D	A	A	C	D	B	B	C	B	A	A	A	A	A	A
Sodium Sulphide	175	79,4	20	D	A	A	D	D	B	B	B	B	D	A	A	A	A	A
Steam	800	426,7		A	A	A	D	D	B	B	B	B	A	C	A	A	B	
Sulphur Chloride, Dry	212	100	100	D	B	C	C	C	C	B	C	B	A	A	A	A	A	A
Sulphur Dioxide, Dry	500	260	100	B	B	B	C	D	B	B	B	B	A	A	A	A	C	
Sulphur Trioxide, Dry	300	148,9		B	B	B	C	C	B	B	A	B	D	A	A	A	A	A
Sulphuric Acid	212	100	10	D	D	D	D	D	D	D	C	B	A	A	A	A	A	A
Sulphuric Acid	212	100	<30	D	D	D	D	D	D	D	B	C	A	B	A	A	A	A
Sulphuric Acid	212	100	100	D	D	D	D	D	D	D	B	B	A	C	A	A	A	A
Sulphuric Acid, Fuming	175	79,4	100	D	A	B	D	D	D	D	B	B	C	C	A	A	B	
Sulphurous Acid	212	100	All	D	C	C	C	C	C	C	C	B	B	A	A	A	A	A
Tannic Acid	212	100	All	C	B	B	B	C	B	B	B	B	A	A	A	A	A	A
Tartaric Acid	212	100		D	A	A	B	C	B	B	B	B	A	A	A	A	A	A
Tin Chloride	125	51,7	All	D	D	D	D	D	D	D	B	B	A	A	A	A	A	A
Titanium Tetrachloride, Dry	75	23,9	100	A	B	B	D	D	B	B	B	B	A	A	A	A	A	A
Toluene	212	100		A	A	A	A	A	A	A	A	A	A	D	A	A	B	
Trichloroacetic Acid	212	100	All	D	D	D	D	D	B	C	B	B	A	D	C	A	C	
Trichloroethane, Dry	125	51,7		A	A	A	A	A	A	A	A	A	A	D	C	A	B	
Trichloroethylene, Dry	300	148,9		B	B	B	B	B	A	A	B	A	A	D	D	A	A	A
Turpentine	75	23,9	100	B	A	A	A	B	A	B	A	A	A	C	A	A	A	A
Urea	100	37,8	50	C	A	A	B	B	B	B	B	B	A	A	A	A	A	A
Varnish	250	121,1		A	A	A	B	B	A	A	A	A	A	D	A	A	A	A
Vynil Chloride	150	65,6	100	C	B	B	C	C	A	A	B	A	A	D	A	A	A	A
Water (demineralized)	212	100		C	A	A	A	B	A	A	A	A	A	A	A	A	A	A
Whiskey (hot mash)	212	100		C	A	A	B	B	A	B	A	A	A	B	A	A	A	A
Zinc Chloride	212	100	<40	D	D	D	C	D	B	B	B	B	A	A	A	A	A	A
Zinc Sulphate	212	100	<30	D	A	A	B	D	B	B	B	B	A	A	A	A	A	A

A = Recommended	Best service life	Attack < 0,05 mm/year
B = Suitable	Good service life	Attack 0,05..0,5 mm/year
C = Not recommended	Fair service life	Attack 0,5..1,27 mm/year
D = Unsuitable	No service life	Attack > 1,27 mm/year

This tab is a guide. The purchaser will directly choose the most suitable material for the process conditions. (The diaphragm thickness goes from 0,05 mm to 0,15 mm according to the material and the diaphragm type chosen) For further information please contact our Service Technical Department.

(1) For this application LEITENBERGER developed special diaphragm seals in special materials that have been subjected to a corrosion test.
For further information please contact our Service Technical Department.